

NAC2014

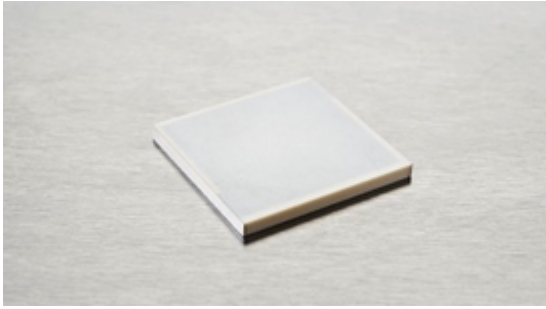

The multilayer piezo actuators can reach full performance at very low operating voltage. The plate actuator NAC2014 is 7x7 mm and provides a free stroke of 3.3 μm and a blocking force of 2060 N.

SPECIFICATIONS

Attributes	Value	Tolerance
Length / outer diameter	7 mm	+/-0.15 mm
Width / inner diameter	7 mm	+/-0.15 mm
Height	2 mm	+/-0.05 mm
Operating voltage, max.	150 V	
Free stroke, max.	3.3 μm	+/- 15%
Blocking force, max.	2060 N	+/-20%
Capacitance	380.00 nF	+/- 15%
Stiffness	624.00 N/ μm	+/-20%
Maximum operating temperature	200 °C	
Material	NCE51F	
Unloaded resonance frequency	>486k Hz	
Electrodes	Screen-printed Ag	

DRAWINGS

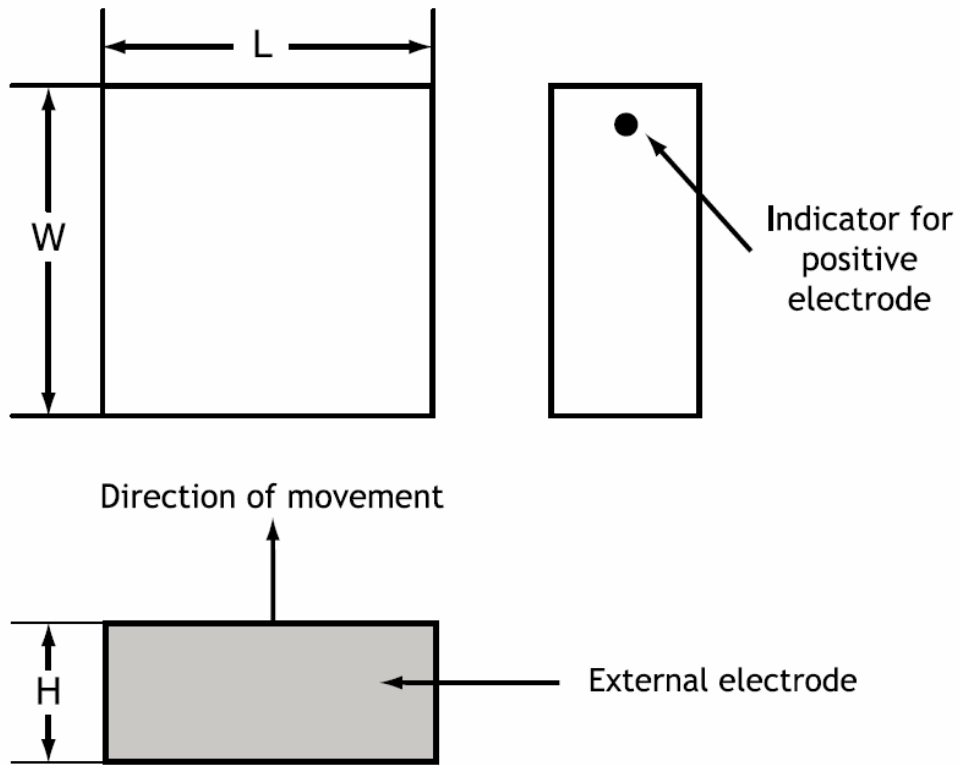

MOUNT AND CONNECT

Mounting

The actuators are usually grinded on top and bottom surfaces (perpendicular to the direction of expansion) in order to obtain flat and parallel surfaces for mounting. The actuators may be mounted either by mechanical clamping or gluing.

Avoiding short circuit can either be achieved by:

Adding Kapton foil on the metallic surfaces.

Having inactive ceramic plates between the actuator and the metal plate.

Stacked actuators are manufactured with top and bottom insulating ceramic end-plates.

If glued, it is important to ensure a very thin glue line between the actuator and the substrate. It is recommended that a pressure, e.g. 2-5 MPa, is applied during the curing process.

To avoid significant loss of performance, the mounting of the actuators should avoid mechanical clamping and/or gluing on the sides of the actuator.

During manufacturing or handling, minor chips on the end-plates can appear. Minor chips cannot be avoided, but such chips do not affect performance.

Electrical connection

External electrodes

The external electrodes are screen printed silver as standard. Other materials, e.g. gold or silver/palladium are available on request. The positive electrode is indicated by a black spot.

Electrical connection to the external electrodes can be achieved by mechanical contacts, soldering, gluing

with electrically conductive glues or wire bonding.

Mechanical connections

Mechanical connections can be arranged by e.g. copper springs contacted to the external electrodes. It is recommended to use external electrodes of gold in order to eliminate oxidation of the electrodes.

Soldering

Soldering electrical wires to the screen-printed silver electrode makes an excellent and time-stable connection. In order to avoid challenges with wetting the solder on the silver surface, always clean the external electrodes with a glass brush or steel wool.

Soldering material must contain Ag.

Gluing wire contacts

Electrical connection can also be arranged by gluing wires to the external silver electrodes. Noliac recommends a two component soft epoxy glue with minimum 75 % silver content and a curing temperature below 150 °C to avoid depolarization of the piezoceramic material. Gluing is recommended as alternative to soldering the wires when the piezo is working at high frequency or the piezo is subjectet to high thermal variations from the environment. It is recommended to use external electrodes of silver in order to archive good electrical contact between glue and electrode.

Wire bonding contacts

Electrical connection can be done by wire bonding to the external gold electrodes. Noliac recommends external gold electrodes as gold generates only a thin oxide layer, which has to be penetrated in the wire bonding friction process and thereby ensures a better mechanical and electrical contact.

The actuators may only be stressed axially. Tilting and shearing forces must be avoided.

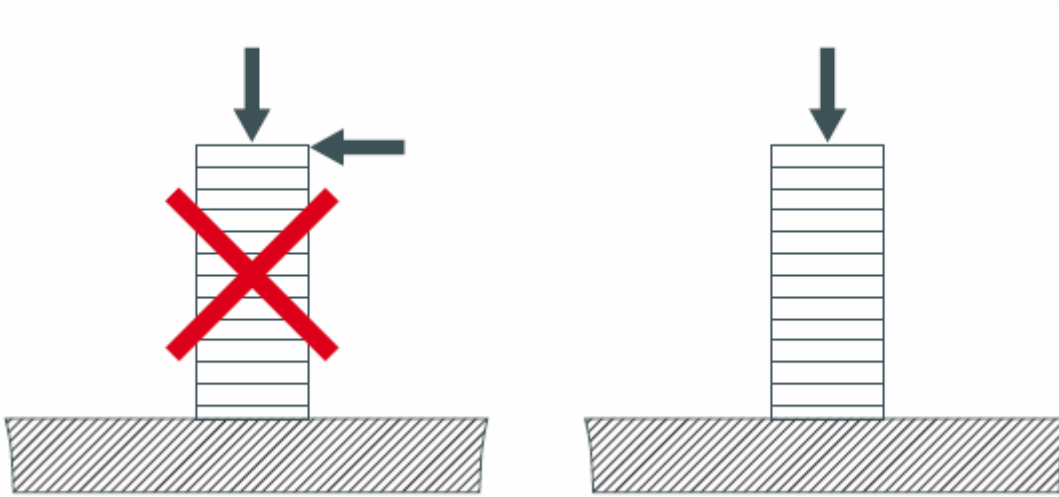

The actuators without preload are sensitive to pulling forces. It is recommended to apply a pre-load in order to optimize the performances of the actuators.

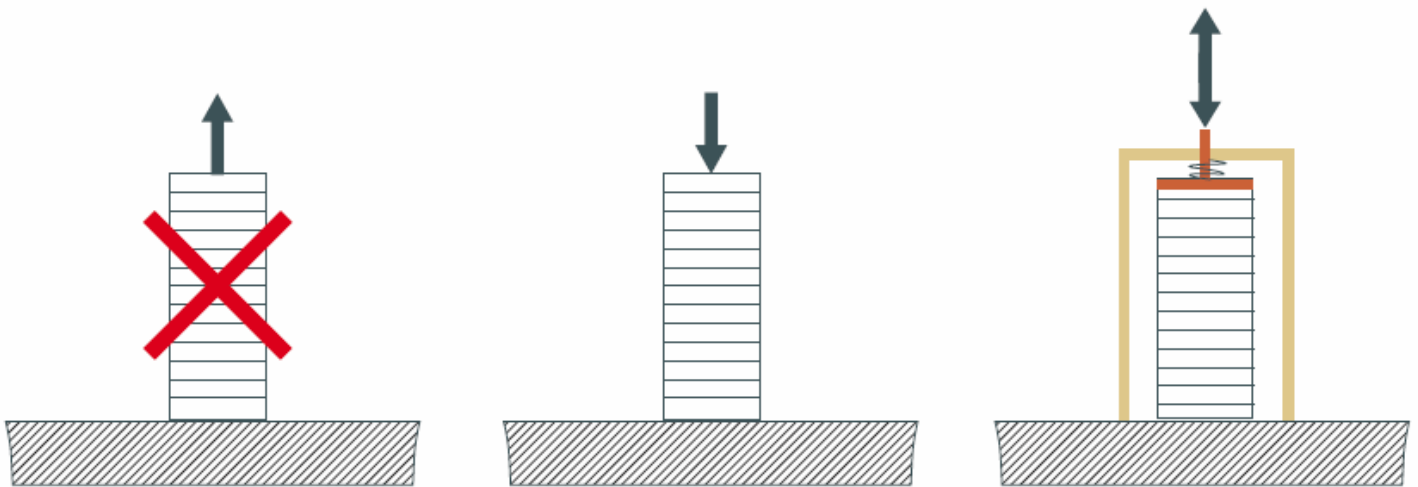

For linear actuators it is recommended not to use a metal plate on top and bottom in order to avoid short circuit.

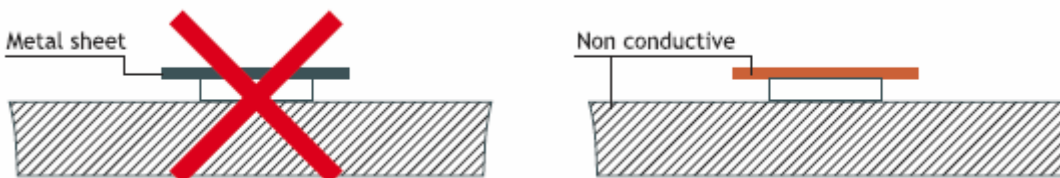

The force must be applied on the full surface of the actuator in order to assure a good load distribution.

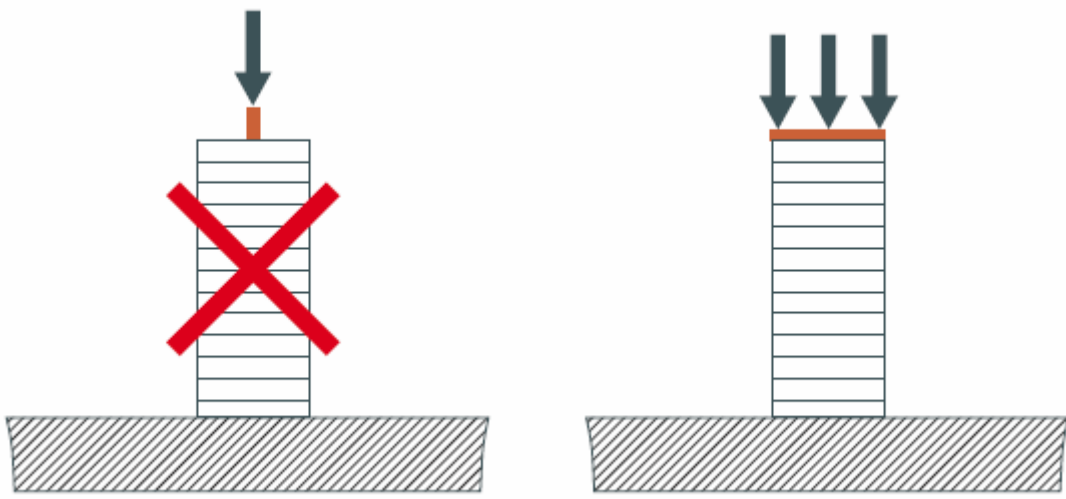

Epoxy glues are well suited for gluing piezoceramics.

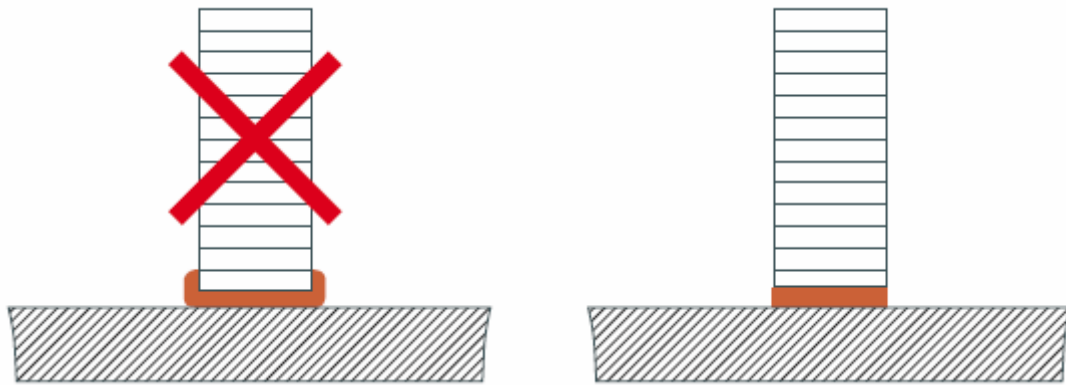

WIRES

When you order actuators from Noliac, you can have wires fitted to save time and money. However, you should consider these parameters, when you select a wire for connection:

- Operation voltage
- Intensity of current
- Operating temperature
- Environment for example vacuum

We recommend Teflon wires

Teflon wires can stand temperatures above 200 °C, whereas PVC wires only resist temperatures up to 80 °C. In tough operating conditions or in vacuum, it is recommended always to use Teflon isolated wire to guarantee the proper performance of PZT-elements.

Wire thickness (AWG)

The wire thickness (AWG) is determined by the current that has to be transmitted to and from the PZT-element. The required current is determined by the capacitance of the PZT-element, the maximum driving frequency and the maximum voltage U_{p-p} .

	Option A01	Option A02	Option C
Type	28 AWG Teflon	28 AWG Teflon	Custom
Length	200 +/- 10mm	200 +/- 10mm	To be defined
Position	Middle of the actuator	Middle of the actuator	To be defined
Direction	Perpendicular to the height	Toward top	To be defined

Type A01

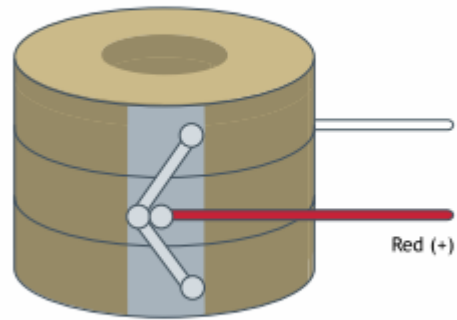
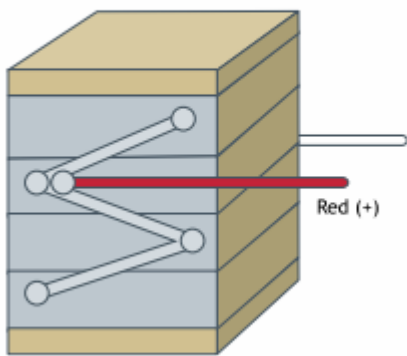

Type A02

