

NAC2122-Hxx



Noliac ring stack actuator NAC2122-Hxx (height in mm - Hxx) is based on the multilayer actuator NAC2122 and can be stacked to match your requirements. The standard range of NAC2122-Hxx is produced in a height between 4-80 mm. The ring stack provides a stroke in a range between 3.3 and 128.7 μm and blocking force up to 1810 N depending on the height of the stack.

SPECIFICATIONS

Attributes	Value	Tolerance
Length / outer diameter	8 mm	+0.45/-0.25 mm
Width / inner diameter	3 mm	+0.10/-0.30 mm
Max width / outer diameter max	9.8 mm	
Height	4 — 80 mm	+/-0.2 mm or 1% (whichever is largest)
Operating voltage, max.	200 V	
Free stroke, max.	3.3 — 128.7 μm	+/- 15%
Blocking force, max.	1810 N	+/-20%
Capacitance	180-7020 nF	+/- 15%
Stiffness	548-14 N/ μm	+/-20%
Maximum operating temperature	150 °C	
Material	NCE51F	
Unloaded resonance frequency	>248k -14k Hz	
Electrodes	Screen-printed Ag and soldered bus wire (option: glued connections)	

Stack options

Height	Stroke	Capacitance
4 mm	3.3 μm	180 nF
6 mm	6.6 μm	360 nF
8 mm	9.9 μm	540 nF
10 mm	13.2 μm	720 nF

12 mm	16.5 μm	900 nF
14 mm	19.8 μm	1080 nF
16 mm	23.1 μm	1260 nF
18 mm	26.4 μm	1440 nF
20 mm	29.7 μm	1620 nF
22 mm	33 μm	1800 nF
24 mm	36.3 μm	1980 nF
26 mm	39.6 μm	2160 nF
28 mm	42.9 μm	2340 nF
30 mm	46.2 μm	2520 nF
32 mm	49.5 μm	2700 nF
34 mm	52.8 μm	2880 nF
36 mm	56.1 μm	3060 nF
38 mm	59.4 μm	3240 nF
40 mm	62.7 μm	3420 nF
42 mm	66 μm	3600 nF
44 mm	69.3 μm	3780 nF
46 mm	72.6 μm	3960 nF
48 mm	75.9 μm	4140 nF
50 mm	79.2 μm	4320 nF
52 mm	82.5 μm	4500 nF
54 mm	85.8 μm	4680 nF
56 mm	89.1 μm	4860 nF
58 mm	92.4 μm	5040 nF
60 mm	95.7 μm	5220 nF
62 mm	99 μm	5400 nF
64 mm	102.3 μm	5580 nF
66 mm	105.6 μm	5760 nF
68 mm	108.9 μm	5940 nF
70 mm	112.2 μm	6120 nF
72 mm	115.5 μm	6300 nF
74 mm	118.8 μm	6480 nF
76 mm	122.1 μm	6660 nF
78 mm	125.4 μm	6840 nF
80 mm	128.7 μm	7020 nF

DRAWINGS

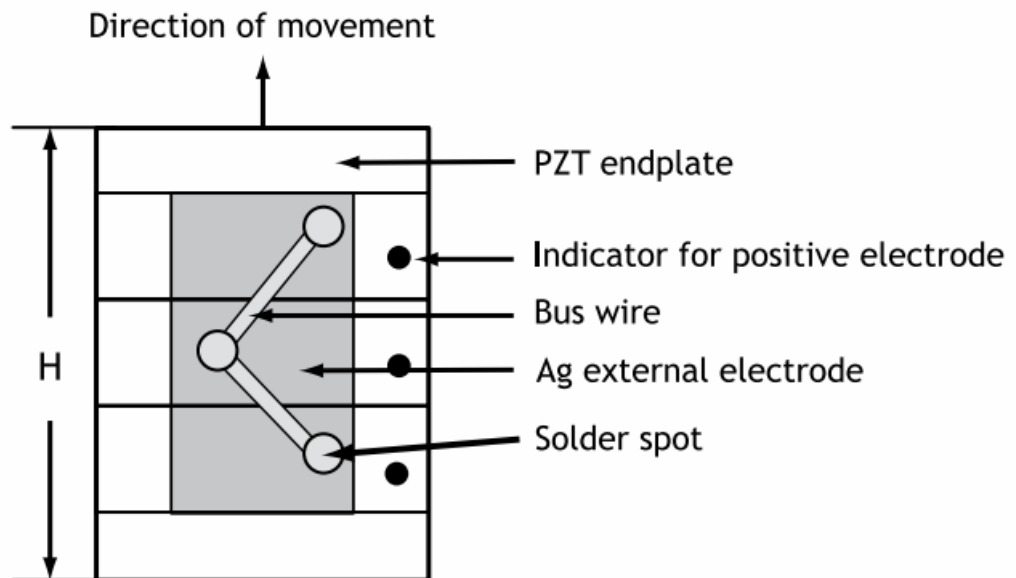
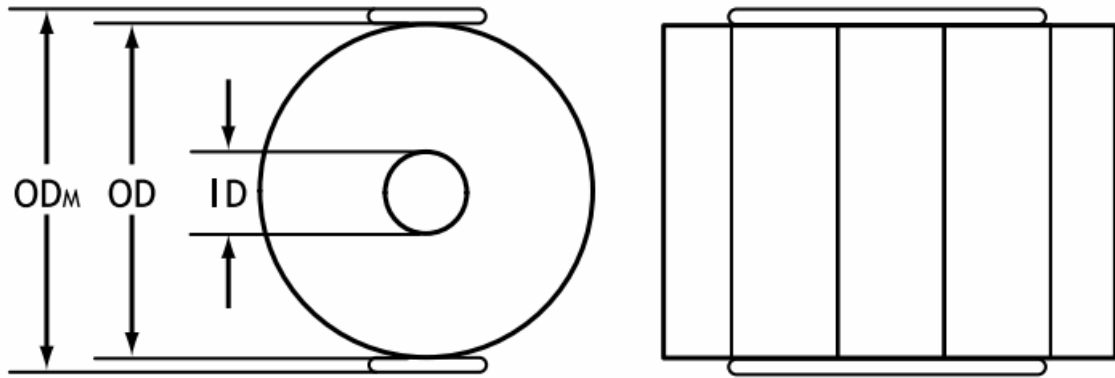

MOUNT AND CONNECT

Mounting

The actuators are usually grinded on top and bottom surfaces (perpendicular to the direction of expansion) in order to obtain flat and parallel surfaces for mounting. The actuators may be mounted either by mechanical clamping or gluing.

Avoiding short circuit can either be achieved by:

- Adding Kapton foil on the metallic surfaces.
- Having inactive ceramic plates between the actuator and the metal plate.
- Stacked actuators are manufactured with top and bottom insulating ceramic end-plates.

If glued, it is important to ensure a very thin glue line between the actuator and the substrate. It is recommended that a pressure, e.g. 2-5 MPa, is applied during the curing process.

To avoid significant loss of performance, the mounting of the actuators should avoid mechanical clamping and/or gluing on the sides of the actuator.

During manufacturing or handling, minor chips on the end-plates can appear. Minor chips cannot be avoided, but such chips do not affect performance.

Electrical connection

External electrodes

The external electrodes are screen printed silver as standard. Other materials, e.g. gold or silver/palladium are available on request. The positive electrode is indicated by a black spot.

Electrical connection to the external electrodes can be achieved by mechanical contacts, soldering, gluing with electrically conductive glues or wire bonding.

Mechanical connections

Mechanical connections can be arranged by e.g. copper springs contacted to the external electrodes. It is recommended to use external electrodes of gold in order to eliminate oxidation of the electrodes.

Soldering

Soldering electrical wires to the screen-printed silver electrode makes an excellent and time-stable connection. In order to avoid challenges with wetting the solder on the silver surface, always clean the external electrodes with a glass brush or steel wool.

The actuators may only be stressed axially. Tilting and shearing forces must be avoided.

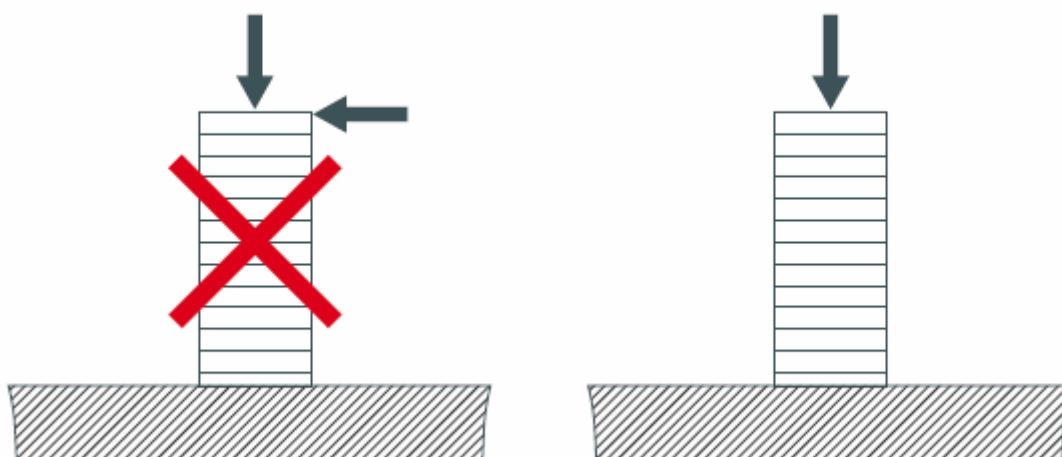

The actuators without preload are sensitive to pulling forces. It is recommended to apply a pre-load in order to optimize the performances of the actuators.

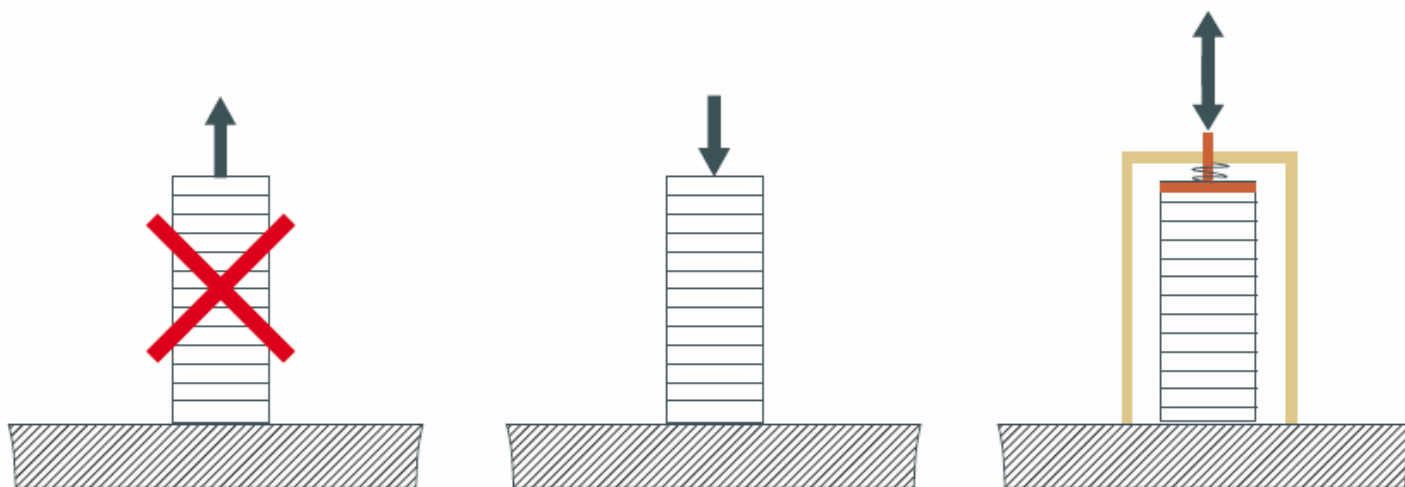

For linear actuators it is recommended not to use a metal plate on top and bottom in order to avoid short circuit.

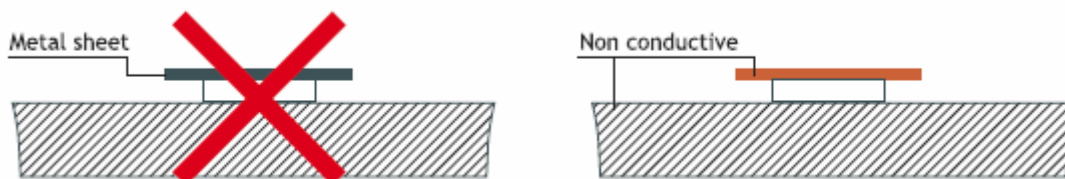

The force must be applied on the full surface of the actuator in order to assure a good load distribution.

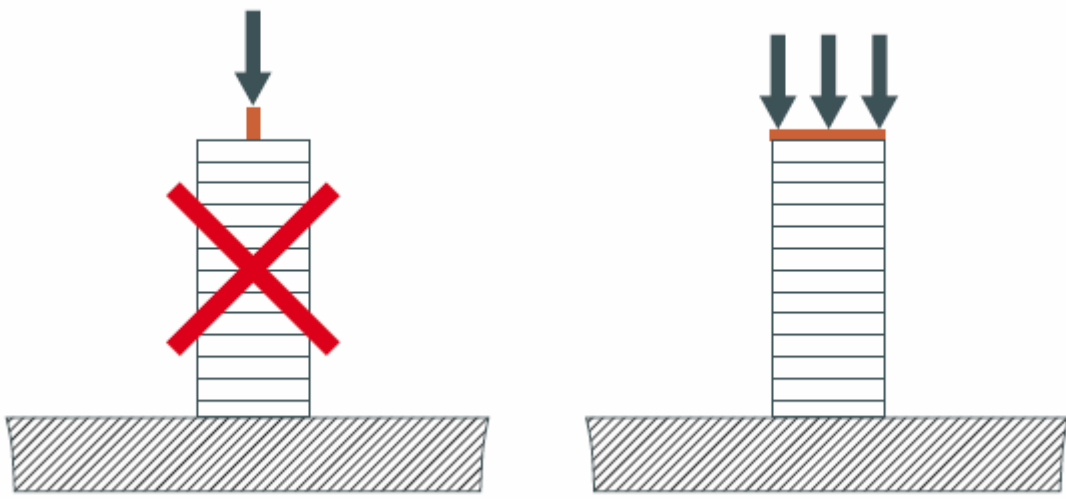

Epoxy glues are well suited for gluing piezoceramics.

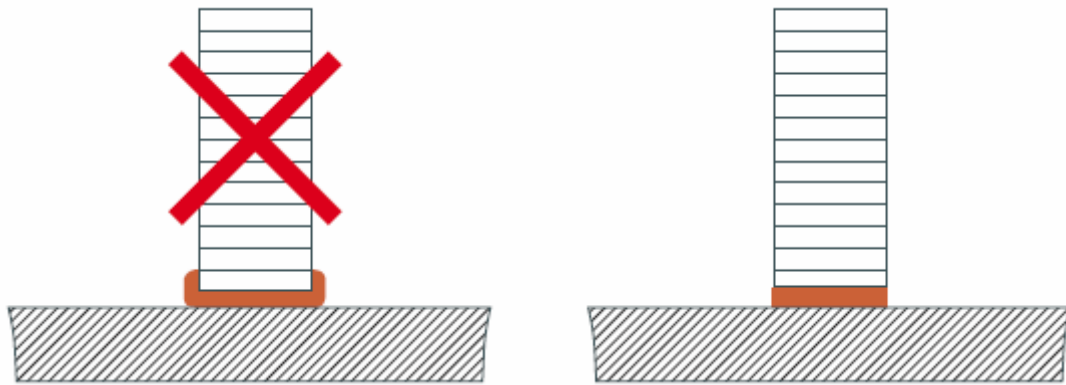

WIRES

When you order actuators from Noliac, you can have wires fitted to save time and money. However, you should consider these parameters, when you select a wire for connection:

- Operation voltage
- Intensity of current
- Operating temperature
- Environment for example vacuum

We recommend Teflon wires

Teflon wires can stand temperatures above 200 °C, whereas PVC wires only resist temperatures up to 80 °C. In tough operating conditions or in vacuum, it is recommended always to use Teflon isolated wire to guarantee the proper performance of PZT-elements.

Wire thickness (AWG)

The wire thickness (AWG) is determined by the current that has to be transmitted to and from the PZT-element. The required current is determined by the capacitance of the PZT-element, the maximum driving frequency and the maximum voltage U_{p-p} .

	Option A01	Option A02	Option C
Type	28 AWG Teflon	28 AWG Teflon	Custom
Length	200 +/- 10mm	200 +/- 10mm	To be defined
Position	Middle of the actuator	Middle of the actuator	To be defined
Direction	Perpendicular to the height	Toward top	To be defined

Type A01

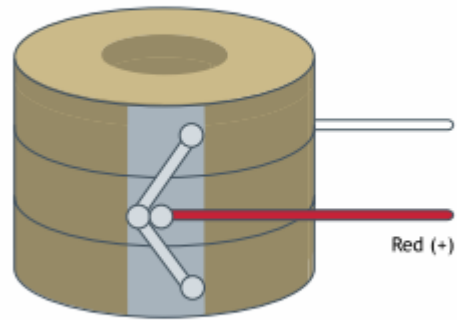
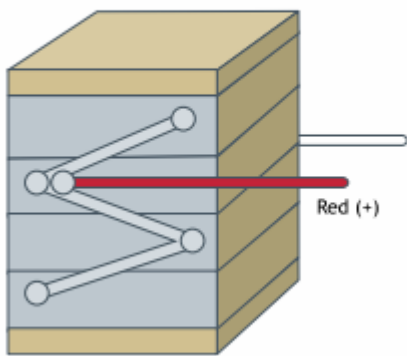

Type A02

