



# CONTENTS

Introduction / References .....	3
Piezoelectric Ceramics .....	4
Ceramic Design Information .....	7
NEPEC® NPM Ceramics .....	12
Applications .....	19
Langevin Bolt-On Transducers .....	20
Transducers for Cleaning Equipment .....	23
Transducers for Ultrasonic Motor .....	24
Piezoelectric Bimorph Actuators .....	25
Multilayer Piezoelectric Actuators .....	26
Molded Waterproof Transducers .....	27
High-Frequency Transducers .....	33
Aerial Microphone Transducers .....	34
Sonar Transducers .....	35



- All specifications in this catalog and production status of products are subject to change without notice. Prior to the purchase, please contact NEC TOKIN for updated product data.
- Please request for a specification sheet for detailed product data prior to the purchase.
- Before using the product in this catalog, please read "Precautions" and other safety precautions listed in the printed version catalog.

# INTRODUCTION

Increasingly, we can see the unique properties of mechanical vibration and ultrasonic waves put to use in many ways. And the single most important key to the effective monitoring or use of vibration is the transducer. Today's transducers are called on for standards of performance that are higher than ever before.

For best results in any application, the piezoelectric materials in the transducer should be selected with the specific use in mind. This catalog contains a wealth of information to help you evaluate transducer characteristics.

And when it comes to the materials themselves, look to NEC TOKIN's NEPEC® NPM piezoelectric ceramics. Using zircon and lead titanate as the main components, NEPEC materials have a wealth of features:

- 1) A wide selection range, especially for mechanical characteristics and degree of electromechanical coupling.
- 2) High stability against temperature and humidity variations and aging.
- 3) Remarkably fine ceramics that can be machined into a variety of sizes and shapes.
- 4) Excellent resistance to voltage, permitting transducers with polarization in any direction.
- 5) A wide range of potential uses.

This catalog describes NEC TOKIN's standard piezoelectric ceramics, and it also describes NEC TOKIN's line of transducers. If you cannot find the desired material characteristics or transducer for your application in these pages, please contact us directly; our engineering staff can work with you to develop materials for your purpose.

## References

Please refer to the following bibliography if you want more details of basic theory and applications of transducers:

- 1) Ultrasonic technology handbook (J. Tomoyoshi et al, Nikkan Kogyo Shinbun)
- 2) Ceramic dielectrics (K. Okazaki, Gakkensha)
- 3) Physical Acoustic Vol I Part A (Mason, Academic Press)
- 4) Piezoelectric ceramic materials (T. Tanaka, Denpa Shinbun)
- 5) Piezoelectric ceramics and their applications (Electronic materials Association, Denpa Shinbun)
- 6) New ultrasonic wave technologies (E. Mori, Nikkan Kogyo Shinbun)
- 7) Ultrasonic engineering (H. Wada, Nikkan Kogyo Shinbun)
- 8) Ultrasonic circuit (S. Ishiwata, Nikkan Kogyo)
- 9) Ultrasonics in medicine (compiled by The Japan Society of Ultrasonics in Medicine, Igaku Shoin)
- 10) Simple applications of ultrasonics (S. Fujimori, Sanpo)
- 11) Electromechanical functional parts (compiled by Specialized Committee of The Institute of Electrical Engineers of Japan)
- 12) Test methods for piezoelectric ceramic transducers (EMAS-6001 to EMAS-6004)  
(Piezoelectric Ceramic Engineering Committee, Electronic Materials Association)
- 13) Piezoelectric / Electrostrictive Actuator (K. Uchino, Morikita Publishers)



- All specifications in this catalog and production status of products are subject to change without notice. Prior to the purchase, please contact NEC TOKIN for updated product data.
- Please request for a specification sheet for detailed product data prior to the purchase.
- Before using the product in this catalog, please read "Precautions" and other safety precautions listed in the printed version catalog.

# Piezoelectric Ceramics

## OPERATING PRINCIPLES OF PIEZOELECTRIC CERAMICS

When considered at the crystal level, a piezoelectric ceramic has the following properties.

A piezoelectric material possesses a perovskite crystalline structure. Lead zirconate titanate  $\text{PbZrO}_3\text{-PbTiO}_3$  (abbreviated to PZT) which is the primary component of the piezoelectric material is used as an example for explanation.

The crystalline structure of PZT becomes cubic (a cube) above a certain temperature known as the Curie temperature ( $T_c$ ) (see Fig. 1-1a). In the cubic structure, three crystallographic axes have the same length ( $a = b = c$ ), and all the angles between the crystallographic axes are  $90^\circ$  ( $\alpha = \beta = \gamma = 90^\circ$ ). A positively charged Zr ion or Ti ion is centered on the lattice. The crystal is electrically balanced at this time, and therefore no electrical polarization arises in the crystal.

However, below the Curie temperature, the crystal structure becomes tetragonal (or assumes a rectangular-parallelpiped shape) or rhomboid. In the tetragonal structure, the c axis is longer than the other two axes ( $a = b \neq c$ ), and all the angles between the axes are  $90^\circ$ . On the other hand, in the rhomboid structure, the three axes have the same length ( $a = b = c$ ), and the angles between the axes are not  $90^\circ$  ( $\alpha = \beta = \gamma \neq 90^\circ$ ).

A typical tetragonal structure will now be described. Below the Curie temperature, the positively charged Zr ion or Ti ion shift from the center. As a result of this, the c axis of the crystal becomes longer, and the resulting electrical imbalance brings about a dipole moment. The Zr ion or Ti ion has equivalent energy even when shifted to any position along the six axes in the crystal (Fig. 1-1b).

If an external electric field is applied to this tetragonal crystal, the Zr ion or Ti ion shift in the direction of the electric field. Even if the electric field is eliminated, the Zr ion or Ti ion do not return to their original positions and stay aligned in the direction of the electric field. As a result of this, the direction of the longer axis changes (Fig. 1-1c). This phenomenon is called  $90^\circ$  inversion. As a matter of course,  $180^\circ$  inversion may also occur. However, in this case, the direction of the long axis remains unchanged.

When an external electric field is applied to the crystal, the Zr ion or Ti ion are attracted to the negative side of the electric field, whereas O (oxygen) ions are attracted to the positive side, resulting in a longer crystal (Fig. 1-1d). Specifically, the application of the external electric field brings the displacement (expansion) of the crystalline lattice. Variations in the length of the crystal can be obtained as displacement in the form of voltage. This is one of the principal factors with respect to the operating principles of the piezoelectric ceramics.



- All specifications in this catalog and production status of products are subject to change without notice. Prior to the purchase, please contact NEC TOKIN for updated product data.
- Please request for a specification sheet for detailed product data prior to the purchase.
- Before using the product in this catalog, please read "Precautions" and other safety precautions listed in the printed version catalog.

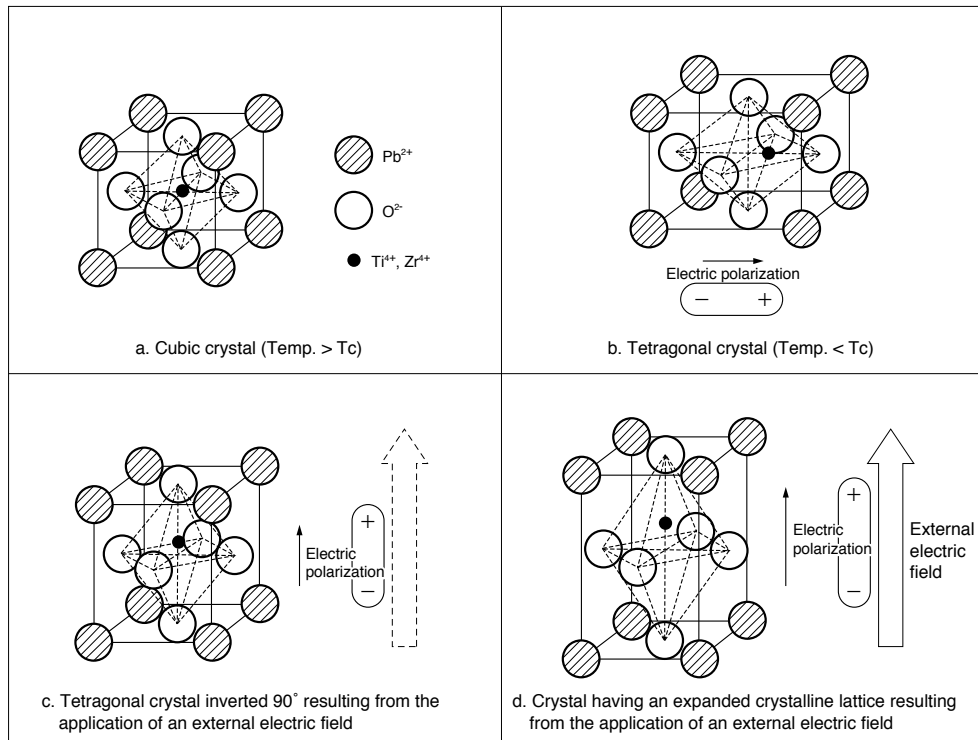

**Fig. 1-1 Behavior of Actuator (Perovskite Crystalline Structure)**

Below the Curie point, as viewed from a macroscopic viewpoint, that is, as considered at the crystal grain level, bounded areas (domains) where the Zr ion or Ti ion of the atoms are aligned in the same direction are generated (Fig. 1-2a). The domains have large Zr ion or Ti ion. The spontaneous polarization cancels each other out, and the Zr ion or Ti ion of the piezoelectric ceramic element as a whole is zero. Such a state is called a nonpolarized state.

If an electric field is applied to the nonpolarized piezoelectric ceramic element, the directions of the Zr ion or Ti ion of the domains are aligned in the direction close to the electric field as a result of the shift of the Zr ion or Ti ion. This phenomenon is called polarization. As a result of this, the length of the piezoelectric ceramic element becomes longer in the direction of the electric field (Fig. 1-2b).

Even if the electric field is eliminated, the length of the piezoelectric ceramic element does not return to its original length in the nonpolarized state as a result of the 90° inversion of the Zr ion or Ti ion. The variation in the length of the element is called residual polarization (Fig. 1-2c). The element is most stable in the nonpolarized state, from the viewpoint of energy. For this reason, the polarization is gradually lost if the element is stored for a long period of time, and the element finally returns to the nonpolarized state.

Some of the Zr ion or Ti ion which are inverted by 90° while the electric field is applied to the element become unstable, in terms of energy, as a result of the influence of the neighboring domains at the moment the electric field is eliminated, and they return to their original positions (their positions when the element was nonpolarized). In other words, when the electric field (a voltage) is applied to the piezoelectric ceramic element, the element becomes longer in the direction of the electric field. On the other hand, when the electric field (a voltage) is eliminated, the element returns to its original length. This variation in the length of the element is the displacement that can be obtained in the form of voltage. The variation in the length of the element is another element of the principal factors with respect to the operating principles of the piezoelectric ceramics.



- All specifications in this catalog and production status of products are subject to change without notice. Prior to the purchase, please contact NEC TOKIN for updated product data.
- Please request for a specification sheet for detailed product data prior to the purchase.
- Before using the product in this catalog, please read "Precautions" and other safety precautions listed in the printed version catalog.

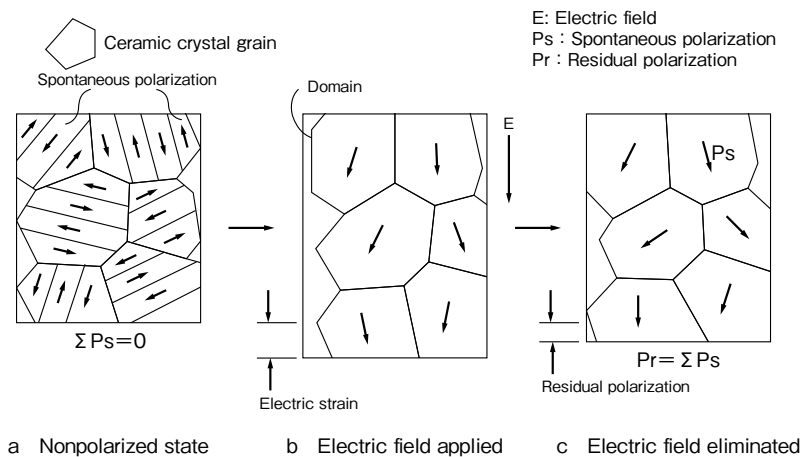

Fig. 1-2 Behavior of Actuator (Crystal Grain)



- All specifications in this catalog and production status of products are subject to change without notice. Prior to the purchase, please contact NEC TOKIN for updated product data.
- Please request for a specification sheet for detailed product data prior to the purchase.
- Before using the product in this catalog, please read "Precautions" and other safety precautions listed in the printed version catalog.



## Evaluation of Transducer Characteristics

NEC TOKIN evaluates the characteristics of transducer materials based on a number of parameters.

### 1) Resonant Frequency

When an AC voltage is applied to the transducer and frequency  $f$  is varied to be in agreement with the natural frequency of the transducer, it vibrates very violently. This frequency is called resonance frequency  $f_r$ .

A constant voltage circuit or a low voltage circuit was used for measurement of the resonance and anti-resonance frequencies. These frequencies can be measured easily with an impedance analyzer such as the 4294A of Agilent Technologies.

Resonance frequency  $f_r$  obtained from the equivalent circuit near the resonance frequency and anti-resonance frequency  $f_a$  can be expressed by the following equations:

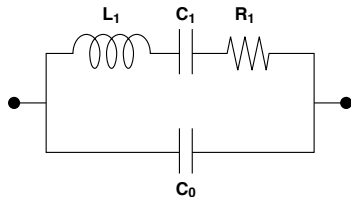

Fig. 2-1 Equivalent circuit of transducer

Where,

- $L_1$  : Series Inductance
- $C_1$  : Series Capacitance
- $C_0$  : Parallel Capacitance
- $R_1$  : Series Resistance

$$f_r = 1 / \{2\pi\sqrt{L_1 C_1}\}$$

$$f_a = 1 / \{2\pi\sqrt{L_1 C_0 C_1 / (C_1 + C_0)}\}$$

Practically, frequencies minimizing and maximizing the impedance shown in Fig. 2-2 are generally treated as  $f_r$  and  $f_a$ , respectively.

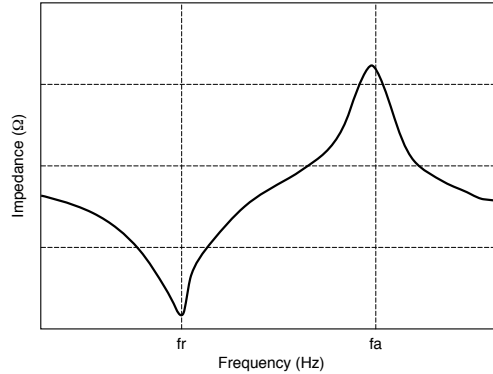
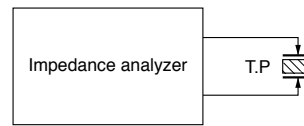

Fig. 2-2 Impedance characteristic of piezoelectric transducer



T.P : Piezo ceramics and holding tool

Fig. 2-3 Impedance measuring circuit

Resonant frequency  $f_r$  can be defined in a number of different ways, depending on the mechanical structure and oscillation of the transducer.

#### a) Radial vibration

$$f_r = \frac{N_1}{D} [\text{Hz}] \dots\dots\dots (1)$$

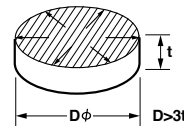

Fig. 2-4

Radial vibration is in the direction of the arrows. The coefficient of electromechanical coupling for this type of vibration is called  $K_r$ .



- All specifications in this catalog and production status of products are subject to change without notice. Prior to the purchase, please contact NEC TOKIN for updated product data.
- Please request for a specification sheet for detailed product data prior to the purchase.
- Before using the product in this catalog, please read "Precautions" and other safety precautions listed in the printed version catalog.



b) **Lengthwise vibration**

$$fr = \frac{N_2}{\ell} [\text{Hz}] \dots\dots\dots (2)$$

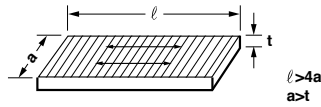

Fig. 2-5

The direction of vibration is perpendicular to the polarization direction; it is a simple vibration in one plane only. The coefficient of electromechanical coupling is known as  $K_{31}$ .

c) **Longitudinal vibration**

$$fr = \frac{N_3}{\ell} [\text{Hz}] \dots\dots\dots (3)$$

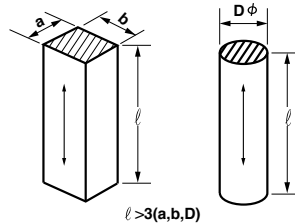

Fig. 2-6

The directions of polarization and vibration are the same, vibration is simple vibration. The electromechanical coupling coefficient is known as  $K_{33}$ .

d) **Thickness vibration**

$$fr = \frac{N_4}{t} [\text{Hz}] \dots\dots\dots (4)$$

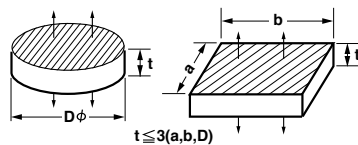

Fig. 2-7

Here, thickness is small compared with the area of the radiation plane; the effect of vibration is the same as that of longitudinal vibration. Generally, vibration is in two directions, and discrimination can be made between the two. The electromechanical coupling coefficient for this type of vibration is called  $K_t$ .

e) **Shear vibration**

$$fr = \frac{N_5}{t} [\text{Hz}] \dots\dots\dots (5)$$

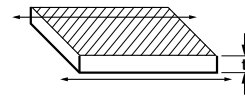

Fig. 2-8

The direction of vibration is the same as the polarization direction. Orientation of the drive field direction is perpendicular to it. A drive electrode is located perpendicular to the direction of polarization. The electromechanical coupling coefficient is expressed by  $K_{15}$ .

Where

$N_1$  : Frequency constant of radial vibration (Hz-m)

$N_2$  : Frequency constant of lengthwise vibration (Hz-m)

$N_3$  : Frequency constant of longitudinal vibration (Hz-m)

$N_4$  : Frequency constant of thickness vibration (Hz-m)

$N_5$  : Frequency constant shear vibration (Hz-m)

$D$  : Diameter of disc or column (m)

$\ell$  : Length of plate, column, or cylinder (m)

$a, b$  : Width of square plate or column (Hz-m)

$t$  : Thickness of disc, square plate, or cylinder (m)

2) **Coefficient of electromechanical coupling**

The coefficient of electromechanical coupling represents the mechanical energy accumulated in a ceramic or crystal; it is related to the total electrical input. This coefficient  $k$  can be calculated for each individual vibration mode by using the resonant ( $fr$  or  $fm$ ) and antiresonant frequencies ( $fa$  or  $fn$ ) and the applicable formula shown here:

$$Kr = \sqrt{\left(0.395 \times \frac{fr}{fa - fr} + 0.574\right)^{-1}} \dots\dots\dots (6)$$

$$K_{31} = \sqrt{\frac{r}{r - \tan r}} \dots\dots\dots (7)$$

$$r = \frac{\pi}{2} \cdot \frac{fa}{fr}$$



● All specifications in this catalog and production status of products are subject to change without notice. Prior to the purchase, please contact NEC TOKIN for updated product data.  
 ● Please request for a specification sheet for detailed product data prior to the purchase.  
 ● Before using the product in this catalog, please read "Precautions" and other safety precautions listed in the printed version catalog.

$$K_{33} = \sqrt{\left(\frac{\pi}{2} \cdot \frac{fr}{fa}\right) \cot\left(\frac{\pi}{2} \cdot \frac{fr}{fa}\right)} \dots\dots\dots (8)$$

$$K_t = \sqrt{\left(\frac{\pi}{2} \cdot \frac{fr}{fa}\right) \cot\left(\frac{\pi}{2} \cdot \frac{fr}{fa}\right)} \dots\dots\dots (9)$$

$$K_{15} = \sqrt{\left(\frac{\pi}{2} \cdot \frac{fr}{fa}\right) \cot\left(\frac{\pi}{2} \cdot \frac{fr}{fa}\right)} \dots\dots\dots (10)$$

Where

Kr : Electromechanical coupling coefficient for radial vibration

K<sub>31</sub>: Electromechanical coupling coefficient for lengthwise vibration

K<sub>33</sub>: Electromechanical coupling coefficient for longitudinal vibration

Kt : Electromechanical coupling coefficient for thickness vibration

K<sub>15</sub>: Electromechanical coupling coefficient for shear vibration

fr : Resonant frequency [Hz]

fa : Antiresonant frequency [Hz]

**3) Relative dielectric constant**

When the electric flux density caused by applying an electric field E between electrodes of a transducer under a constant stress is regarded as D, the relative dielectric constant is obtained by dividing the constant, defined by D/E=ε<sup>r</sup>, by the vacuum dielectric constant ε<sub>0</sub>. This relative dielectric constant is expressed by ε<sup>T</sup><sub>33</sub>/ε<sub>0</sub> when the direction of polarization and applied electric field are the same; it is expressed by ε<sup>T</sup><sub>11</sub>/ε<sub>0</sub> when these directions are perpendicular. Calculation of relative dielectric constant is shown in Eq. 11. Static capacitance is usually measured at 1kHz using an all-purpose bridge or a C meter.

$$\epsilon_{33}^T / \epsilon_0 = \frac{tC}{\epsilon_0 S} \dots\dots\dots (11)$$

(ε<sup>T</sup><sub>11</sub>/ε<sub>0</sub> is also calculated using the same equation.)

Where

ε<sub>0</sub> : Relative dielectric constant in vacuum (8.854x10<sup>-12</sup> F/m)

t : Distance between electrodes (m)

S : Electrode area (m<sup>2</sup>)

C : Static capacitance (F)

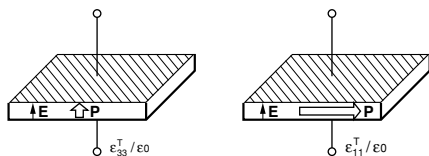

Fig.2-9

**4) Young's modulus**

For different modes of vibration, Young's modulus is calculated by Eq. 12, based on the sonic velocity and density of the material.

$$Y^E = \rho v^2 [N/m^2] \dots\dots\dots (12)$$

Where ρ: Density (kg/m<sup>3</sup>)

v(=2frℓ): Sonic velocity (m/sec.)

N: Newton

**5) Mechanical Q**

The mechanical Q is the "sharpness" of mechanical vibration at resonant frequency, and is calculated with Eq 13.

$$Q_m = \frac{fa^2}{2\pi fr Z_r C (fa^2 - fr^2)} \dots\dots\dots (13)$$

Where fr : Resonant frequency (Hz)

fa : Antiresonant frequency (Hz)

Z<sub>r</sub>: Resonant resistance (Ω)

C : Static capacitance (F)

Where a simpler method is called for, mechanical Q may be calculated with Eq. 14, using frequencies f<sub>1</sub> and f<sub>2</sub> which are each 3 dB from the resonant frequency.

$$Q_m = \frac{fr}{f_1 - f_2} \dots\dots\dots (14)$$

The values shown for material characteristics in this catalog are calculated using Eq. 13.

**6) Piezoelectric constant**

There are two types of piezoelectric constants, the piezoelectric strain constant and the coefficient of voltage output.

**a) Piezoelectric strain constant**

This is a measure of the strain that occurs when a specified electric field is applied to a material that is in the condition of zero stress. This constant is calculated with Eq. 15.

$$d = k \sqrt{\frac{\epsilon^T}{Y^E}} (m/V) \dots\dots\dots (15)$$

Where k : Coefficient of electromechanical coupling

ε<sup>T</sup>: Dielectric constant

Y<sup>E</sup>: Young's modulus (Newton/m<sup>2</sup>)



● All specifications in this catalog and production status of products are subject to change without notice. Prior to the purchase, please contact NEC TOKIN for updated product data.  
 ● Please request for a specification sheet for detailed product data prior to the purchase.  
 ● Before using the product in this catalog, please read "Precautions" and other safety precautions listed in the printed version catalog.

b) Voltage output constant

This is the intensity of the electric field caused when a specified amount of stress is applied to a material that is in the condition of zero displacement. Voltage output constant is calculated with Eq. 16.

$$g = \frac{d}{\epsilon} (V \cdot m/N) \dots\dots\dots (16)$$

Constants d and constants g can be d<sub>31</sub>, d<sub>33</sub>, or d<sub>15</sub>, and g<sub>31</sub>, g<sub>33</sub>, or g<sub>15</sub>, depending on the type of vibration.

7) Curie temperature

This is the temperature at which polarization disappears and the piezoelectric qualities are lost. It is also the temperature at which the value of the dielectric constant becomes maximum.

8) Temperature coefficient

The temperature coefficient is a measure of the variation of the resonant frequency and static capacitance with change in temperature. Temperature coefficient is calculated with Eqs. 17 and 18.

$$TK(f) = \frac{1}{\Delta t} \cdot \frac{f(t_1) - f(t_2)}{f_{20}} \cdot 10^6 (PPm/^\circ C) \dots\dots (17)$$

$$TK(C) = \frac{1}{\Delta t} \cdot \frac{C(t_1) - C(t_2)}{C_{20}} \cdot 10^6 (PPm/^\circ C) \dots\dots (18)$$

- Where TK(f) : Temperature coefficient of resonant frequency (PPm/°C)  
 f (t<sub>1</sub>) : Resonant frequency at temperature t<sub>1</sub>°C(Hz)  
 f (t<sub>2</sub>) : Resonant frequency at temperature t<sub>2</sub>°C(Hz)  
 f<sub>20</sub> : Resonant frequency at temperature 20°C(Hz)  
 TK(C) : Temperature coefficient of static capacitance (PPm/°C)  
 C (t<sub>1</sub>) : Static capacitance (F) at temperature t<sub>1</sub>°C  
 C (t<sub>2</sub>) : Static capacitance (F) at temperature t<sub>2</sub>°C  
 C<sub>20</sub> : Static capacitance at 20°C(F)  
 Δt : Temperature difference (t<sub>2</sub>-t<sub>1</sub>) (°C)

9) Aging rate

The aging rate is an index of the change in resonant frequency and static capacitance with age. To calculate this rate, after polarization the electrodes of a transducer are shorted together, and are heated for a specified period of time. Measurements are taken of the resonant frequency and static capacity every 2<sup>n</sup> days. (That is, at 1, 2, 4, and 8 days.) The aging rate is calculated with Eq. 19.

$$(AR) = \frac{1}{\log t_2 - \log t_1} \cdot \frac{X_{t_2} - X_{t_1}}{X_{t_1}} \dots\dots\dots (19)$$

- Where (AR) : Aging rate for resonant frequency or static capacitance  
 t<sub>1</sub>, t<sub>2</sub> : Number of days aged after polarization  
 X<sub>t1</sub>, X<sub>t2</sub> : Resonant frequency or static capacitance at t<sub>1</sub> and t<sub>2</sub> days after polarization

10) Density

The density is calculated with Eq. 20, after determining the volume and weight of the specified ceramic material.

$$D = \frac{W}{V} (kg/m^3) \dots\dots\dots (20)$$

- Where W : Weight (kg) of ceramic material  
 V : Volume (m<sup>3</sup>) of material



●All specifications in this catalog and production status of products are subject to change without notice. Prior to the purchase, please contact NEC TOKIN for updated product data.  
 ●Please request for a specification sheet for detailed product data prior to the purchase.  
 ●Before using the product in this catalog, please read "Precautions" and other safety precautions listed in the printed version catalog.

# NEPEC® NPM Ceramics



## Characteristics of Standard Materials

Table 1-1 shows the material characteristics of NEC TOKIN's standard NEPEC® NPM ceramics.

Non-standard materials that are not listed in table 1-1 are available.

Please contact us for further information.

### Notes

1. Frequency constants;
  - N1 : Radial frequency constant ( $f_r \times D$ )
  - N2 : Lengthwise frequency constant ( $f_r \times \ell$ )
  - N3 : Longitudinal frequency constant ( $f_a \times \ell$ )
  - N4 : Thickness frequency constant ( $f_a \times \ell$ )
  - N5 : Shear frequency constant ( $f_a \times \ell$ )
2. The temperature and aging characteristics shown are values of radial vibration for a sample of  $17.7\phi \times 1.0t$  (mm) in size.
3. The values of  $K_r$  (electromechanical coupling coefficient) shown in parentheses are approximate values. All others are exact.
4. Vibration limit speed:
  - Please refer to page 14 for the detail.
5. A tensor symbol of each parameter is below.

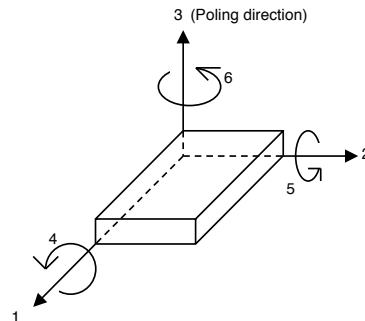

$d_{31}$   
 Displacement (or Stress) is 1 axis direction  
 A normal line of electrode surface is 3 axis direction  
 (Direction of an electric field)

$d_{15}$   
 Displacement direction of share mode is direction of 2 axis rotation  
 A normal line of electrode surface is 1 axis direction

$s_{11}$   
 Stress (or displacement) is 1 axis direction  
 Displacement (or stress) is 1 axis direction



● All specifications in this catalog and production status of products are subject to change without notice. Prior to the purchase, please contact NEC TOKIN for updated product data.  
 ● Please request for a specification sheet for detailed product data prior to the purchase.  
 ● Before using the product in this catalog, please read "Precautions" and other safety precautions listed in the printed version catalog.

Table 1-1. Characteristics of Standard NEPEC® NPM Materials

Characteristics	Unit	N6	N61	N85	N10	N17	N21
Relative dielectric constants	$\epsilon_{33}^T/\epsilon_0$	1400	1400	1800	5440	4360	1800
	$\epsilon_{11}^T/\epsilon_0$	1350	1300	1890	5000	3890	2000
Dielectric loss	$\tan \delta$ (%)	0.3	0.3	0.6	2.0	2.3	2.0
Frequency constants	$N_1$ (Radial) (Hz-m)	2160	2160	2270	2040	1920	1960
	$N_2$ (Lengthwise) (Hz-m)	1600	1570	1660	1410	1380	1410
	$N_3$ (Longitudinal) (Hz-m)	1510	1490	1530	1370	1340	1310
	$N_4$ (Thickness) (Hz-m)	1960	2010	2040	1800	1880	1940
	$N_5$ (Share) (Hz-m)	970	1170	960	1110	820	860
Electromechanical coupling factors	$K_r$ (%)	55	56	63	62	64	62
	$K_{31}$ (%)	34	33	36	34	37	38
	$K_{33}$ (%)	68	67	64	68	67	73
	$K_t$ (%)	55	52	53	62	51	52
	$K_{15}$ (%)	71	66	70	66	67	77
Piezoelectric constants d	$d_{31}$ ( $\times 10^{-12}$ m/V)	-133	-132	-157	-328	-294	-198
	$d_{33}$ ( $\times 10^{-12}$ m/V)	302	296	314	635	579	417
	$d_{15}$ ( $\times 10^{-12}$ m/V)	419	464	562	930	882	711
Piezoelectric constants g	$g_{31}$ ( $\times 10^{-3}$ Vm/N)	-10.4	-10.7	-9.7	-6.0	-7.6	-12.1
	$g_{33}$ ( $\times 10^{-3}$ Vm/N)	23.5	23.8	19.5	13.2	15.0	25.4
	$g_{15}$ ( $\times 10^{-3}$ Vm/N)	45.1	39.4	33.6	21.5	25.8	41.0
Compliances	$S_{11}^E$ ( $\times 10^{-12}$ m <sup>2</sup> /N)	12.7	13.1	11.7	14.8	16.6	16.5
	$S_{33}^E$ ( $\times 10^{-12}$ m <sup>2</sup> /N)	15.4	15.6	14.9	18.1	19.2	19.9
	$Y_{33}^E$ ( $\times 10^{10}$ N/m <sup>2</sup> )	6.5	6.4	6.7	5.5	5.2	5.0
	$Y_{11}^E$ ( $\times 10^{10}$ N/m <sup>2</sup> )	7.9	7.6	8.5	6.8	6.0	6.1
Poisson's ratio	$\delta$	0.32	0.31	0.29	0.34	0.35	0.34
Mechanical quality factor	$Q_m$	1500	1800	1940	70	60	75
Curie Temperature	$T_c$ (°C)	325	315	250	145	190	330
Density	$\rho$ ( $\times 10^3$ kg/m <sup>3</sup> )	7.77	7.79	7.74	8.00	7.93	7.82
Temperature coefficient	$Tk$ (fr) (-20~20°C) ppm/°C	300	600	-90	200	-460	-300
	$Tk$ (fr) (20~60°C) ppm/°C	300	400	-80	900	30	-150
	$Tk$ (C) (-20~20°C) ppm/°C	1800	700	3200	3800	5900	3500
	$Tk$ (C) (20~60°C) ppm/°C	2300	3000	4700	3500	8500	3000
Aging rate	fr (%/10 Years)	0.4	0.4	0.5	0.5	0.5	0.1
	C (%/10 Years)	-2	-2	-3	-5	-5	-5
Vibration velocity	$V_{max}$ ( $\Delta T=20^\circ\text{C}$ ) (m/s)	0.47	0.47	0.56	—	—	—
Major application		Fish Finder	Ultrasonic Cleaner	Fish Finder	Actuator	Actuator	Sensor
		Ultrasonic Cleaner	Ultrasonic Tooling	Ultrasonic Element		Acoustic Device	Sonar
		Aerial Microphone	Ultrasonic Motor	Ultrasonic Motor			Ultrasonic Diagnostic

\* Listed catalogue data is typical value and NOT guaranteed value. These values are measured by NEC TOKIN's measuring condition. Data would be changed by product dimension and poling condition.



- All specifications in this catalog and production status of products are subject to change without notice. Prior to the purchase, please contact NEC TOKIN for updated product data.
- Please request for a specification sheet for detailed product data prior to the purchase.
- Before using the product in this catalog, please read "Precautions" and other safety precautions listed in the printed version catalog.

### Limit of Vibration Speed

Vibration energy of piezoelectric transducer is shown as  $P=(Mv^2)/2$ , ( i.e. M=Mass, v=Vibration speed.)

The large vibration energy can vibrate larger object such as ultrasonic cleaning equipment.

In general, the piezoelectric transducer generates heat as the displacement increases. The heat constrains the displacement. Our new material N85 can provide larger displacement at 0.5V or higher voltage compared with the displacement of the N6 material. Please refer to Fig. 3-1.

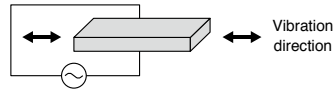

Sample dimension: 12 × 3 × 1 mm

Driving condition: Apply continuous sine wave signal at resonance frequency.

Definition of resonance frequency: The frequency where phases (time) of the operating voltage and the current overlaps.

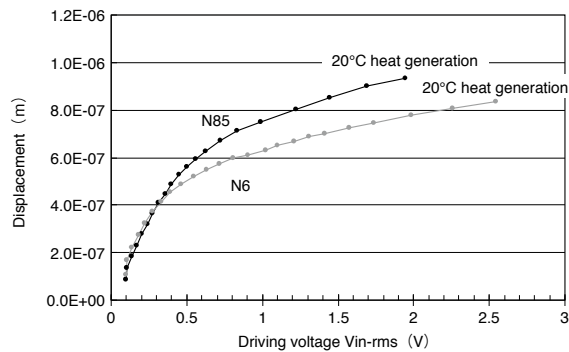

Fig. 3-1 Heat generation in driving voltage (N6 vs. N85)

In addition, N85 material can supply larger vibration energy compared with N6 material because the heat generation of the N85 material is smaller than the heat generation of the N6 material given a same displacement value.

The vibration velocity can be used as an index of material performance rather than displacement value because it shows how the material behaves under different conditions such as different shapes and different frequencies. The vibration speed,  $v_{max}$ , is specified as a performance index for vibration energy when self heat generation is 20 degree C in Fig 3-2 below.

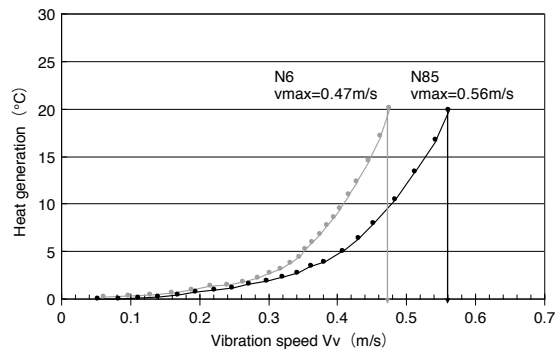

Fig. 3-2 Heat generation in vibration speed (N6 vs. N85)



- All specifications in this catalog and production status of products are subject to change without notice. Prior to the purchase, please contact NEC TOKIN for updated product data.
- Please request for a specification sheet for detailed product data prior to the purchase.
- Before using the product in this catalog, please read "Precautions" and other safety precautions listed in the printed version catalog.





## Design Piezoelectric Ceramic Products

Piezoelectric ceramic is custom design product on order. Followings are typical product shape, terminal layout and external surface example.

### Ceramic shapes

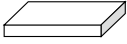
The typical ceramic shapes are shown in Table 2-1. For inquiries about special shape, please contact us.

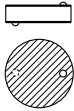

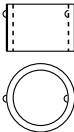

Table 2-1 Example of Ceramic shapes

Types	Bar shape	Disk shape	Ring shape	Cylinder shape
shape				

### Terminal Layout

The three types of terminal layout are shown in Table 2-2 for the disc and cylindrical shapes. Layout of terminals for the column, square plate, and square column shapes are the same as right. For inquiries about special terminal configurations, please contact us.

Table 2-2 Types of Terminal Layout

Terminals	P-terminal	S-terminal	O-terminal
Disc			
Cylinder			
Description	Terminals (solder dots) provided on positive and negative electrode surfaces.	Negative electrode terminal is available on positive electrode surface.	Negative electrode terminal is available on side face.

### External Surface

NEC TOKIN transducers are coated for protection, for uniformity of the electromechanical interface, and to ensure an attractive external view. Table 2-3 shows the different types of surface coatings available. Select the coating that is best for your requirements.

Table 2-3. Types of External Coating

Coating	Features	Coating Surfaces	Standard Color
M Coating	Synthetic resin; resists water and oil. Suitable for fish-finding sonars and air excitation.	All surfaces are coated	Silver gray
B Coating	Bakelite resin; resists solvents. Suitable for ultrasonic cleaning.	All surfaces are coated	Dark brown (Bakelite color)



- All specifications in this catalog and production status of products are subject to change without notice. Prior to the purchase, please contact NEC TOKIN for updated product data.
- Please request for a specification sheet for detailed product data prior to the purchase.
- Before using the product in this catalog, please read "Precautions" and other safety precautions listed in the printed version catalog.

**Example of custom design ceramic products**

Example of custom design ceramic products are shown in Table 2.4. Please note, there are not standard products. For inquiries about ceramic product specification, please contact us.

**Table 2-4 Example of Custom Product Specification**

	Shape (mm)	Material	fr (kHz)	K	C (pF)
Cylinder	NR 38 × 34 × 30	N-21	24	0.25	26500
	36 × 31 × 30	N-21	25.8	0.25	19600
Disc	ND 10 × 0.3	N-21	6400	0.57	3000
	20 × 0.5	N-21	4000	0.6	7000
	40 × 2.5	N-6	54	0.6	5600
	40 × 3.0	N-6	54	0.6	4600
	50 × 2.5	N-6	43	0.6	8900
	50 × 3.0	N-6	43	0.6	7400
Column	60 × 5.0	N-6	36	0.6	6500
	ND 7 × 13.5	N-21	100	0.65	48
	7 × 16.5	N-21	80	0.65	40
	10 × 13.5	N-21	100	0.65	98
Square Plate	10 × 16.5	N-21	80	0.65	90
	NS 20 × 20 × 0.3	N-21	6500	0.3	13500
	20 × 20 × 0.4	N-21	5000	0.3	10500
	25 × 25 × 0.5	N-21	4000	0.3	14000
	80 × 15 × 0.3	N-21	6500	0.3	42000
	80 × 15 × 0.4	N-21	5000	0.3	32500
	100 × 15 × 0.5	N-21	4000	0.3	33000
100 × 15 × 0.6	N-21	3000	0.3	28500	



- All specifications in this catalog and production status of products are subject to change without notice. Prior to the purchase, please contact NEC TOKIN for updated product data.
- Please request for a specification sheet for detailed product data prior to the purchase.
- Before using the product in this catalog, please read "Precautions" and other safety precautions listed in the printed version catalog.



Selected Material Characteristics

a) Temperature characteristics

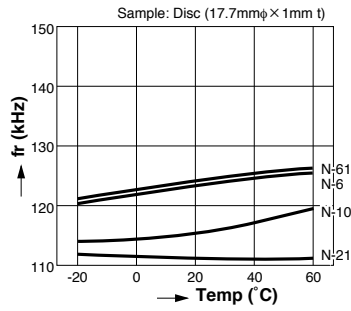

Fig.4-1 Variation in Resonant Frequency with Temperature

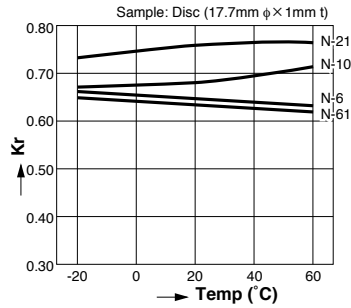

Fig.4-2 Variation in Electromechanical Coupling Coefficient with Temperature

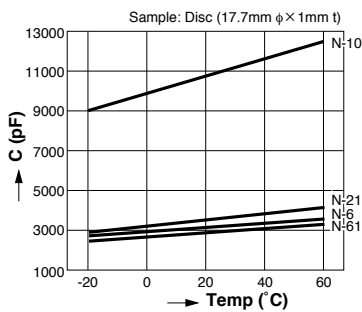

Fig.4-3 Variation in Static Capacitance with Temperature

b) Aging characteristics

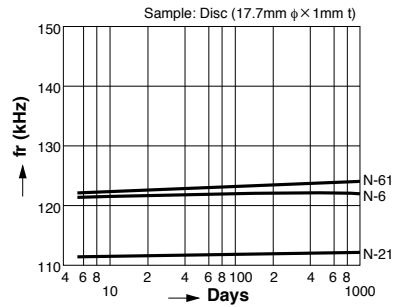

Fig.4-4 Variation in Resonant Frequency with Aging

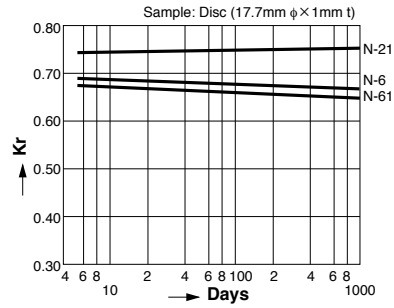

Fig.4-5 Variation in Electromechanical Coupling Coefficient with Aging

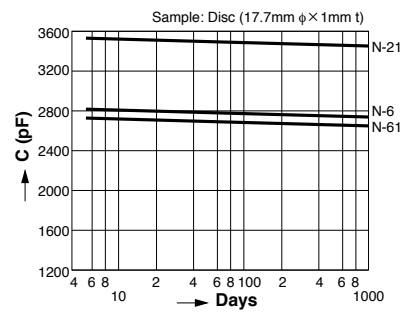

Fig.4-6 Variation in Static Capacitance with Aging



- All specifications in this catalog and production status of products are subject to change without notice. Prior to the purchase, please contact NEC TOKIN for updated product data.
- Please request for a specification sheet for detailed product data prior to the purchase.
- Before using the product in this catalog, please read "Precautions" and other safety precautions listed in the printed version catalog.

c) Thermal aging characteristics

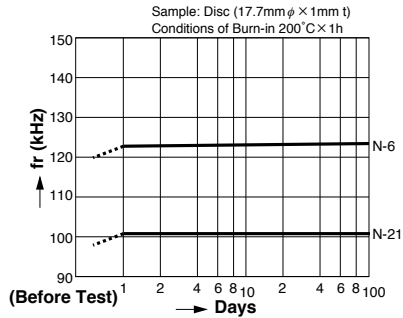

Fig.4-7 Variation in Resonant Frequency with Thermal Aging

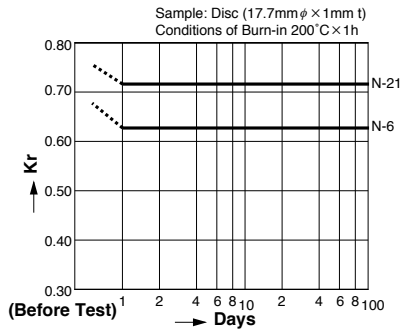

Fig.4-8 Variation in Electromechanical Coupling Coefficient with Thermal Aging

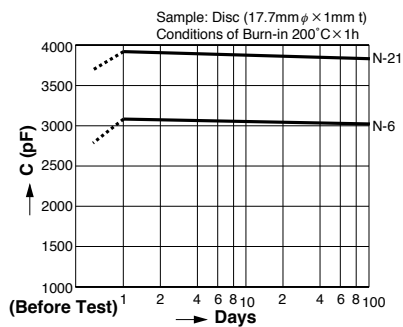

Fig.4-9 Variation in Static Capacitance with Thermal Aging

d) Characteristics of high-voltage aging

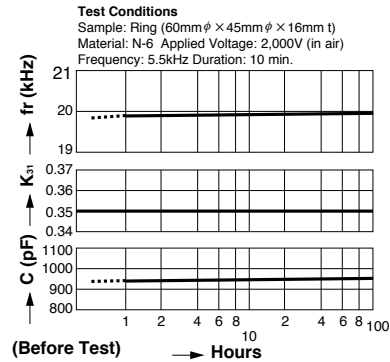

Fig.4-10 Variation in Dielectric Strength (Test 1)

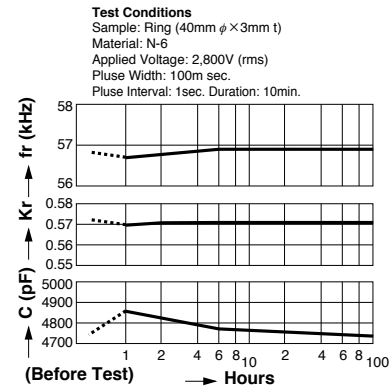

Fig.4-11 Variation in Dielectric Strength (Test 2)

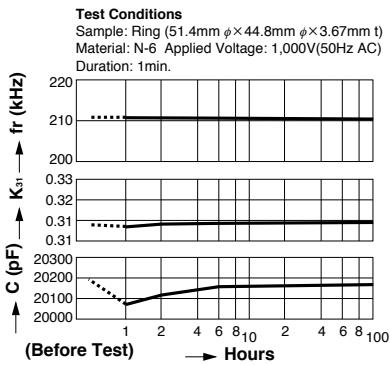

Fig.4-12 Variation in Dielectric Strength (Test 3)



● All specifications in this catalog and production status of products are subject to change without notice. Prior to the purchase, please contact NEC TOKIN for updated product data.  
● Please request for a specification sheet for detailed product data prior to the purchase.  
● Before using the product in this catalog, please read "Precautions" and other safety precautions listed in the printed version catalog.

# Applications

The job of a transducer is to convert electrical energy into mechanical energy, and vice versa. And transducers using NEC TOKIN piezoelectric ceramics are uniquely suited to performing this job in a wide variety of applications. To help classify transducers, we divide their applications into two general areas:  
1) conversion of electrical energy into mechanical energy for hydraulic or motive power, and  
2) converting mechanical energy into electrical energy for communications and electronics.

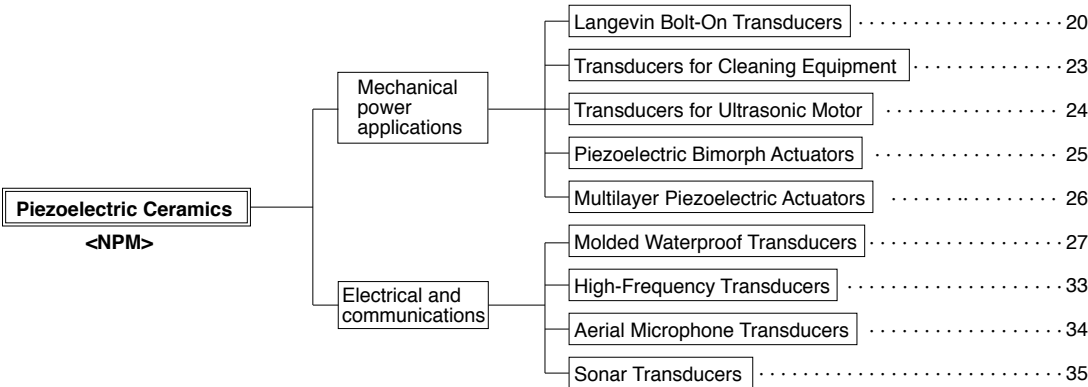

<b>Piezoelectric Ceramics</b> <NPM>	
Mechanical power applications	
Langevin Bolt-On Transducers	20
Transducers for Cleaning Equipment	23
Transducers for Ultrasonic Motor	24
Piezoelectric Bimorph Actuators	25
Multilayer Piezoelectric Actuators	26
Electrical and communications	
Molded Waterproof Transducers	27
High-Frequency Transducers	33
Aerial Microphone Transducers	34
Sonar Transducers	35



● All specifications in this catalog and production status of products are subject to change without notice. Prior to the purchase, please contact NEC TOKIN for updated product data.  
● Please request for a specification sheet for detailed product data prior to the purchase.  
● Before using the product in this catalog, please read "Precautions" and other safety precautions listed in the printed version catalog.

# Langevin Bolt-on Transducers



## Outline

NEC TOKIN's Langevin-type transducers are used where powerful ultrasonic waves must be generated, such as in cleaning equipment, ultrasonic treatment machines, and welders for plastic. For application flexibility and ease of installation, these transducers are mounted in a structure that can be bolted almost anywhere.

NEC TOKIN's high-performance NEPEC® N-61 is excellent for use in these Langevin transducers. NEC TOKIN produces a number of this type of transducer, all featuring high quality and excellent output levels, and all based on a unique NEC TOKIN design.

## Features

- High mechanical Q and excellent electro-acoustic conversion efficiency, providing a high output amplitude.
- Piezoelectric element offers a high speed of vibration
- N-61 ceramics have extended temperature range, ensuring good amplitude linearity.
- Bolt-on mounting gives fast, easy installation and high reliability.

## Markings

Product models are classified as shown in the example here:

**NBL 45 28 2 H**

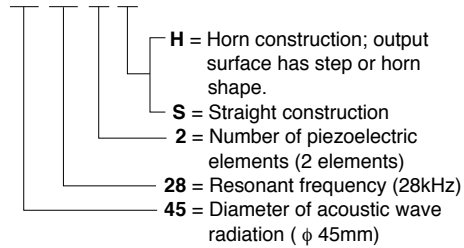

## <For Cleaning Equipment>

### Specifications of Standard Models

Table 3-1

Item		Type	
		45282H-A	45402H-A
Resonant frequency	fo (kHz)	28.0	40.2
Dynamic admittance	Yo (mS)	40	15
Mechanical Q	Qm	500	500
Static capacitance	C (pF)	4000	4000
Maximum allowable velocity	V (cm / S)	40	50
Maximum allowable power	P (W)	50	50
Applications		Cleaning Equipment	

**Note:** Maximum allowable power is based on the data where one unit is measured with a water load on one side.



- All specifications in this catalog and production status of products are subject to change without notice. Prior to the purchase, please contact NEC TOKIN for updated product data.
- Please request for a specification sheet for detailed product data prior to the purchase.
- Before using the product in this catalog, please read "Precautions" and other safety precautions listed in the printed version catalog.

Shape and Dimensions

NBL-45282H-A

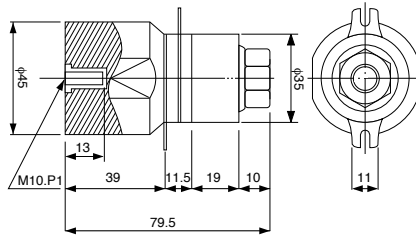

NBL-45402H-A

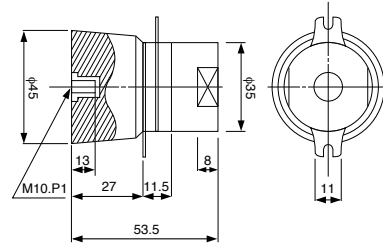

Fig. 5-1

Temperature Characteristics

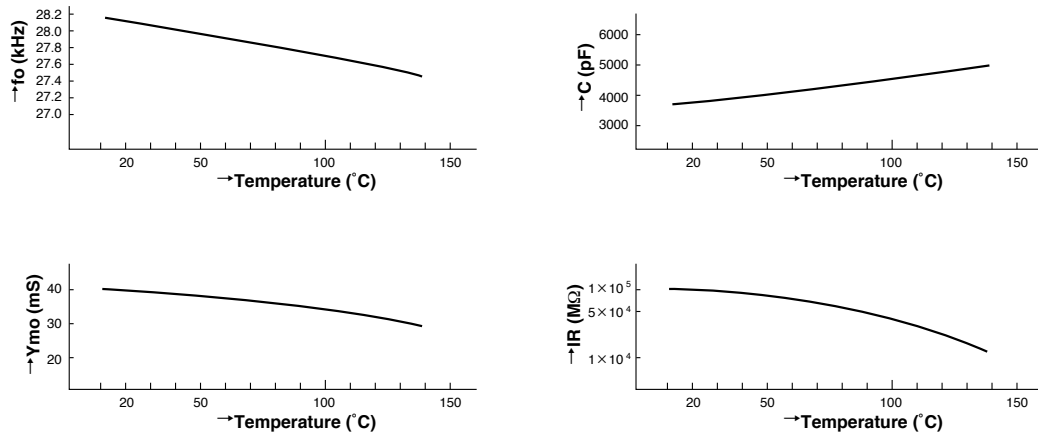

Fig. 5-2 Temperature Characteristics of NBL-45282H-A



- All specifications in this catalog and production status of products are subject to change without notice. Prior to the purchase, please contact NEC TOKIN for updated product data.
- Please request for a specification sheet for detailed product data prior to the purchase.
- Before using the product in this catalog, please read "Precautions" and other safety precautions listed in the printed version catalog.

<For Treatment Machines>

Specifications of Standard Models

Table 3-2

Item		Type	
		NBL15602S	NBL20602S
Resonant frequency	fo (kHz)	60	60
Dynamic admittance	Ymo (mS)	25	20
Mechanical Q	Qm	500	400
Static capacitance	C (pF)	850	1250
Maximum allowable velocity	V <sub>0-P</sub> (cm / S)	50	40
Maximum Allowable power	P (W)	2.5	3.7
Applications		Treatment Machines	

Note) Maximum allowable input in no-load state

Shape and Dimensions

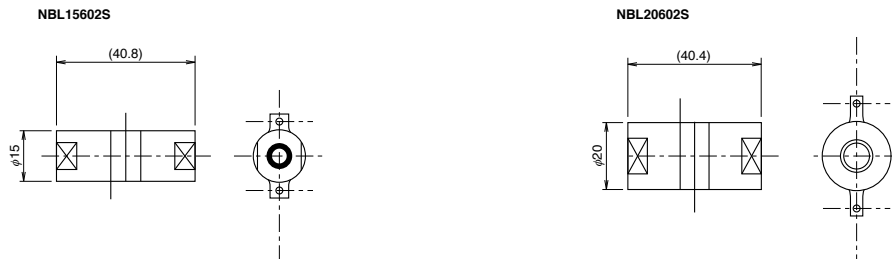

Fig. 5-3

Horn Installation Reference Example

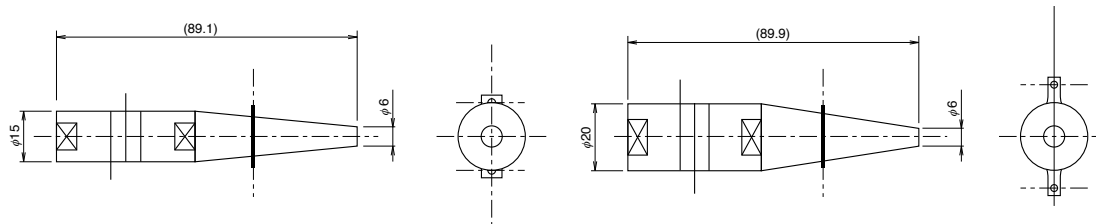

Fig. 5-4

Vibration

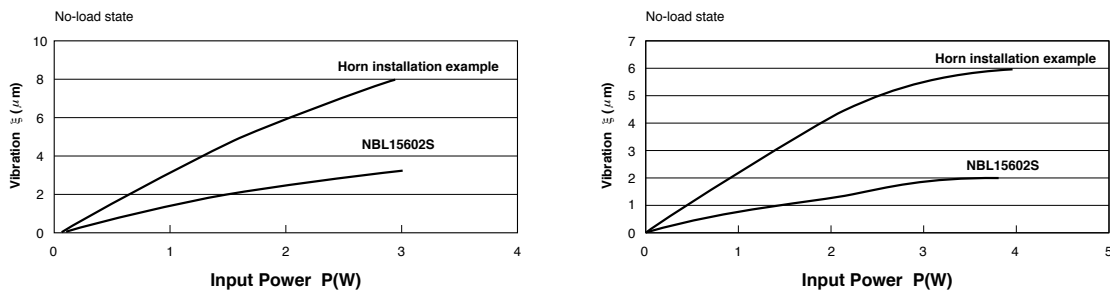

Fig. 5-5



- All specifications in this catalog and production status of products are subject to change without notice. Prior to the purchase, please contact NEC TOKIN for updated product data.
- Please request for a specification sheet for detailed product data prior to the purchase.
- Before using the product in this catalog, please read "Precautions" and other safety precautions listed in the printed version catalog.

# Transducers for Cleaning Equipment

## Outline

In the past, transducers for cleaning equipment have been found almost exclusively in ultrasonic cleaners for industrial and business use. Today, however, small cleaning equipment for glasses, false teeth, gemstones, etc. is increasingly found in individual households as well. NEC TOKIN's transducers for cleaning equipment utilize our N-6 material, providing ultrasonic generators that are compact and extraordinarily temperature-resistant.

## Specifications

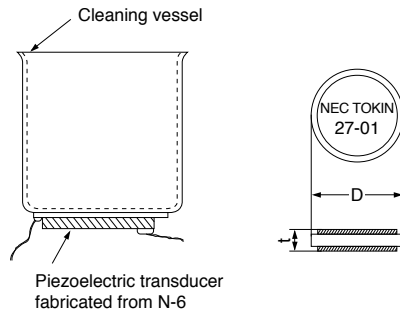

Fig. 5-6 Product Diagram

## Specification Example

Table 3-3

D (mm)	t (mm)	fr (kHz)	Kr	C (PF)
40	2.5	54	0.60	5600
40	3.0	54	0.60	4600
50	2.5	43	0.60	8900
50	3.0	43	0.60	7400
60	5.0	36	0.60	6500

## Temperature Characteristics

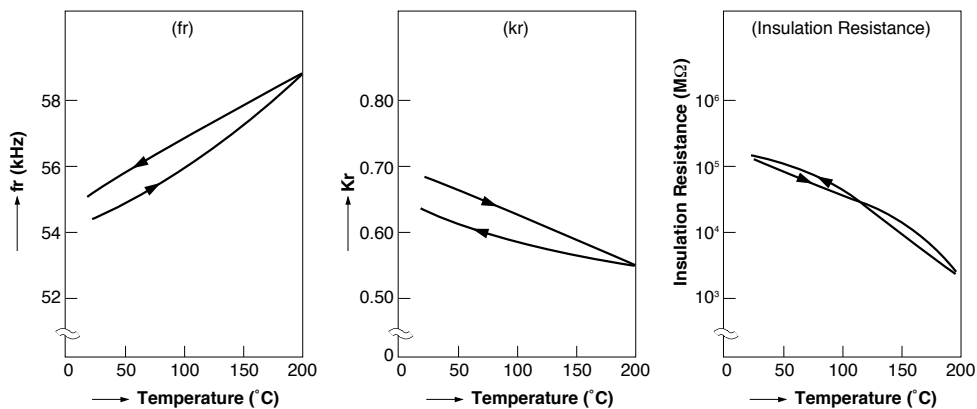
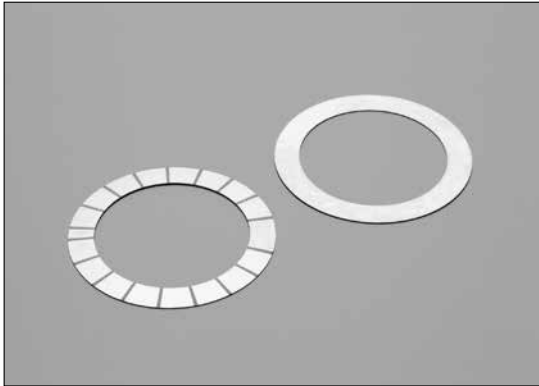

Fig. 5-7 Variation in N-6 Characteristics with Temperature



- All specifications in this catalog and production status of products are subject to change without notice. Prior to the purchase, please contact NEC TOKIN for updated product data.
- Please request for a specification sheet for detailed product data prior to the purchase.
- Before using the product in this catalog, please read "Precautions" and other safety precautions listed in the printed version catalog.

# Transducers for Ultrasonic Motor



## Outline

The moving principal of ultrasonic motor is shown in Fig. 5-8. Piezoelectric actuator that is crimped with an elastic vibrator (stator) generates high-order bending vibration on the surface of the stator. A traveling wave is generated by excitation of the stator vibration. A slider and the stator are cramped together with high pressure and the slider is rotated by friction force at contact point of the stator.

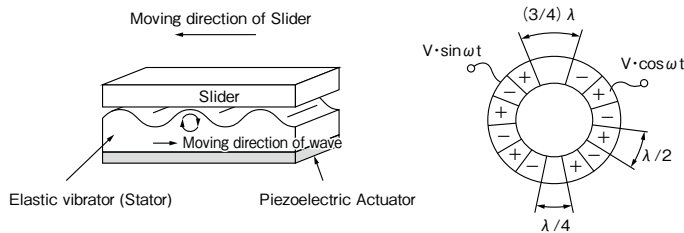

Fig. 5-8 Moving principal of ultrasonic motor

## Feature

Following is feature compare with conventional electro magnetic motor

- Simple structure with nonmagnetic material
- High static torque
- Precise positioning
- Quick response and high torque in all rotation speed

## Ceramic material of Ultrasonic motor

Following material characteristics are required for the ultrasonic motor.

- Low loss factor → High Q hard material
- Large displacement by increase number of rotation → High  $V_{max}$  value.
- Generates high rotation with low voltage → High electromechanical coupling factor K31





# Piezoelectric Bimorph Actuators

## Outline

A bimorph element has two bonded piezoelectric ceramic plates that are poled in thickness direction and expand/contract in length direction. It bends when one plate expands and another plate contracts. It is used for actuator and sensor applications as relatively large displacement can be obtained.

NEC TOKIN can develop custom bimorph elements from bonded type bimorph to co-fired type bimorph that does not use organic glue.

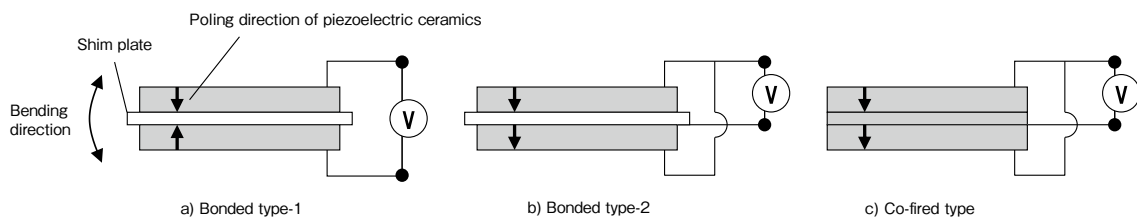

Fig. 5-9 Structure of Piezo Bimorph

## Feature

- Simple Structure and production
- Large Displacement with Low Operating Voltage
- Low Operation Noise

## Application

- Piezo Valves
- Flow Sensors
- Acoustic Devices (Speakers)
- Piezo Fans and etc.



# Multilayer Piezoelectric Actuators

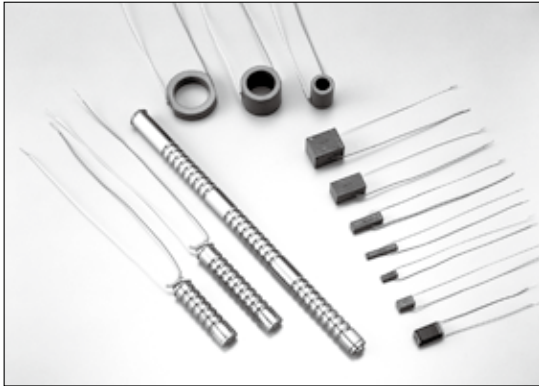

## Feature

### AE Series:

- \* Large generated force
- \* High-speed response
- \* Accurate positioning
- \* Low power consumption
- \* Very small size

### ASB, ASL and AHB Series

- \* High reliability
- \* Easier installation with built-in pre-load mechanism and mounting attachment
- \* Minimum mechanical abrasion
- \* Large generated force
- \* Accurate positioning

## Outline

Multilayer piezoelectric actuators are co-fired ceramic elements for converting electrical energy into mechanical energy such as displacement or force by utilizing the piezoelectric longitudinal effect.

NEC TOKIN's multilayer piezoelectric actuators are produced based on our unique element structure design by making use of originally developed piezoelectric ceramic material with high electrostrictive factors. Compared to conventional piezoelectric actuators, they are smaller in size but can generate higher displacement and force at low voltages. AE-series actuators that is resin coated version feature compact size and wide variety in shape for use in ultra-fine positioning mechanisms and drive sources for various application.

The metal sealed ASB, ASL and AHB series actuators are much less influenced by ambient humidity because of insulation from the atmosphere. As a result, long service life and high performance never experienced of in the past have been attained to allow use in various application such as semiconductor device production equipment and optical communication equipment requiring high reliability.

## Application

- \* Image stabilization of DSC, Auto focus of camera, Precision positioning, Linear motors, Pumps, Valves, Vibration source, Vibration suppression, Sensor, Position control of optical system, Manipulators, AFM, Printer, X-Y stage of a stepper and etc.

NEC TOKIN's multilayer piezoelectric actuators are available in four series.

For the detail information, please refer to a catalogue of "Multilayer Piezoelectric Actuators".

Resin-coated type	Metal case type
General-purpose	High-performance General-purpose
85°C rated AE series	85°C rated ASB series
	150°C rated ASL series
	High displacement model AHB series

\*AE series is resin-coated products. Therefore we recommend using metal case type, ASB, ASL and AHB series in high humidity condition.



# Molded Waterproof Transducers



## Outline

Transducers that can withstand salt water and underwater pressures are used to generate ultrasonic signals for fish finders, sonar equipment, depth gauges, and Doppler-effect velocity and current meters.

NEC TOKIN's molded transducers are highly reliable, even in the face of severe underwater conditions. Completely waterproof, they offer excellent mechanical strength and temperature characteristics, thanks in part to their unique NEC TOKIN design and technology. By using a variety of different materials for our molded transducers, we can offer a large variety of frequency, input, and directivity characteristics.

## Features

- High reliability, thanks to NEC TOKIN's own molding technology, including solid urethane rubber molding and baked neoprene rubber.
- Excellent noise characteristics.
- Wide range of frequencies and molding materials available.

## Markings

Product models are classified as shown in the following example:

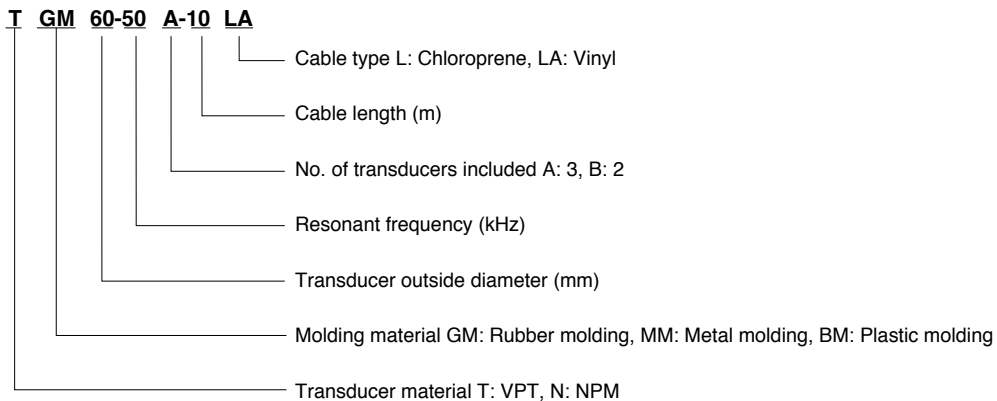

- All specifications in this catalog and production status of products are subject to change without notice. Prior to the purchase, please contact NEC TOKIN for updated product data.
- Please request for a specification sheet for detailed product data prior to the purchase.
- Before using the product in this catalog, please read "Precautions" and other safety precautions listed in the printed version catalog.

Specifications of Standard Models

Table 4-1

Model	Resonant Frequency (kHz)	Impedance ( $\Omega$ ) at Resonance	Static Capacitance (pF)	Insulation Resistance ( $M\Omega$ )	Directivity	Shape
TGM60-40-10L	40	150 ~ 400	7500	500 and over	50°	A
TGM60-45-10L	45	150 ~ 400	7500	500 and over	45°	A
TGM60-50-10L	50	150 ~ 350	8000	500 and over	44°	A
TGM42-75-10L	75	200 ~ 600	3400	500 and over	36°	A
TGM80-75-12L	75	300 ~ 800	2500	500 and over	20°	A
TGM100-100-15L	100	200 ~ 400	4500	500 and over	12°	A
TGM50-200-10L	200	100 ~ 400	2400	500 and over	11°	A
TGM80-200-20L	200	50 ~ 200	5500	500 and over	7°	A
TGM100-200-20L	200	30 ~ 100	7500	500 and over	6°	A
TMM60-50-10LA	50	100 ~ 300	8000	500 and over	44°	B
TMM50-200-10LA	200	200 ~ 400	2500	500 and over	11°	B
TGM60-50A-15L	50	50 ~ 150	23000	500 and over	12° × 44°	E
TGM50-200A-15L	200	70 ~ 150	5500	500 and over	5° × 11°	E
TGM60-50B-12L	50	100 ~ 300	15000	500 and over	13° × 44°	D
TGM46-68B-12L	68	50 ~ 200	12700	500 and over	11° × 38°	D
TGM42-75B-12L	75	50 ~ 200	9000	500 and over	11° × 36°	D
TGM50-200B-12L	200	150 ~ 400	4300	500 and over	11°	D
NBM40-50-8LA	50	150 ~ 350	2800	500 and over	60°	C
TBM50-200-8LA	200	200 ~ 450	2800	500 and over	11°	C

Physical Characteristics

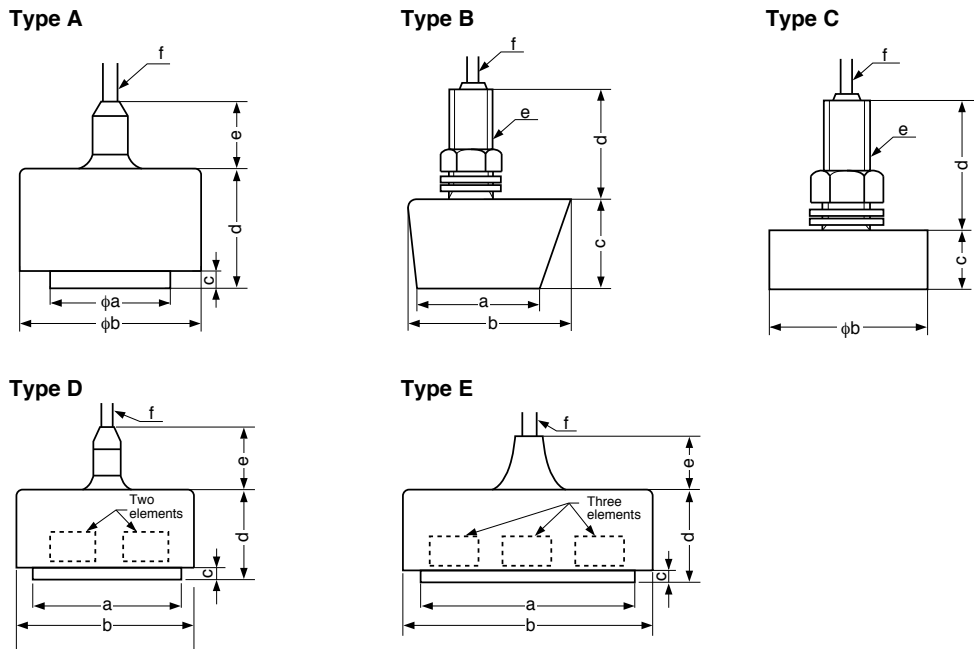

Fig. 6-1 Shape and Construction



- All specifications in this catalog and production status of products are subject to change without notice. Prior to the purchase, please contact NEC TOKIN for updated product data.
- Please request for a specification sheet for detailed product data prior to the purchase.
- Before using the product in this catalog, please read "Precautions" and other safety precautions listed in the printed version catalog.

Table 4-2

Model	Dimensions					f (cable)	Shape
	a	b	c	d	e		
TGM60-40-10L	69.5	89.5	5.0	78.0	60.0	φ 11, two-core shield capture cable (chloroprene)	A
TGM60-45-10L	69.5	89.5	5.0	78.0	60.0		
TGM60-50-10L	69.5	89.5	5.0	60.0	60.0		
TGM42-75-10L	47.8	61.0	4.0	43.0	27.0		
TGM80-75-12L	104.0	120.0	5.0	65.0	30.0		
TGM100-100-15L	120.0	130.0	4.0	55.0	40.0		
TGM50-200-10L	69.5	89.0	5.0	60.0	60.0		
TGM80-200-20L	100.0	120.0	7.0	45.0	30.0		
TGM100-200-20L	124.0	140.0	7.0	45.0	30.0		
TMM60-50-10LA	80.0	100.0	56	120	W • 1.11d/ inch		
TMM50-200-10LA							
TGM60-50A-15L	206.0	226.0	7.0	160.0	60.0	φ 11, two-core shield capture cable (chloroprene)	E
TGM50-200A-15L							
TGM60-50B-12L	140.0	160.0	5.0	60.0	50.0	φ 11, two-core shield capture cable (chloroprene)	D
TGM46-68B-12L							
TGM42-75B-12L							
TGM50-200B-12L							
NBM40-50-8LA							
TBM50-200-8LA	–	68.0	31.0	120.0	M • 22 P1.5	φ 5, two-core shield capture cable (vinyl)	C



- All specifications in this catalog and production status of products are subject to change without notice. Prior to the purchase, please contact NEC TOKIN for updated product data.
- Please request for a specification sheet for detailed product data prior to the purchase.
- Before using the product in this catalog, please read "Precautions" and other safety precautions listed in the printed version catalog.

Typical Directivity Patterns (1)

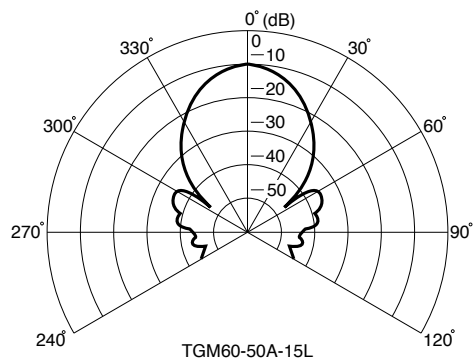
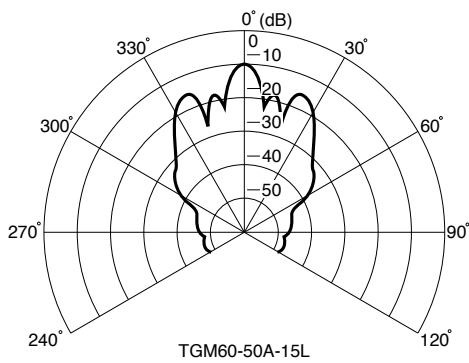
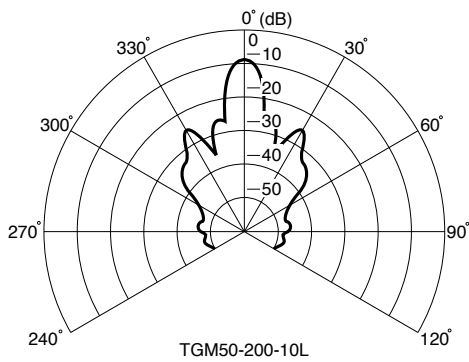
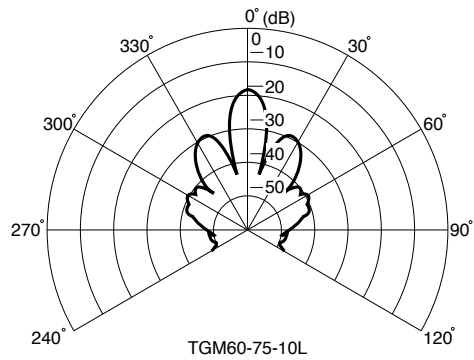
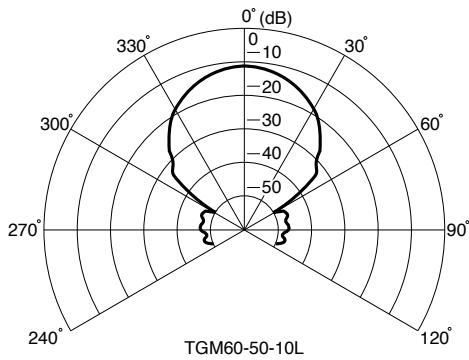

Fig. 6-2 Directivity



- All specifications in this catalog and production status of products are subject to change without notice. Prior to the purchase, please contact NEC TOKIN for updated product data.
- Please request for a specification sheet for detailed product data prior to the purchase.
- Before using the product in this catalog, please read "Precautions" and other safety precautions listed in the printed version catalog.

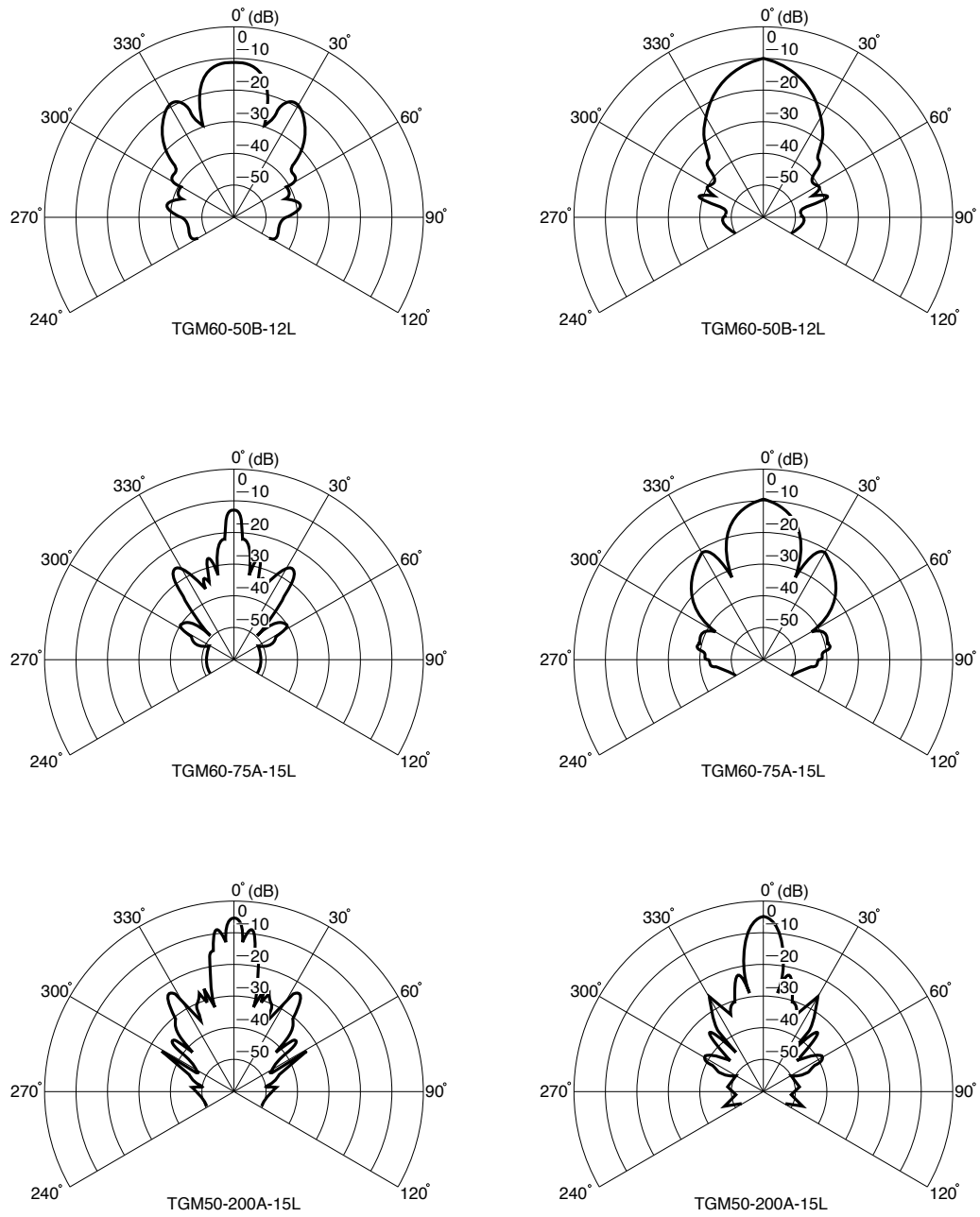

Fig. 6-3 Directivity



- All specifications in this catalog and production status of products are subject to change without notice. Prior to the purchase, please contact NEC TOKIN for updated product data.
- Please request for a specification sheet for detailed product data prior to the purchase.
- Before using the product in this catalog, please read "Precautions" and other safety precautions listed in the printed version catalog.

Typical Directivity Patterns (2)

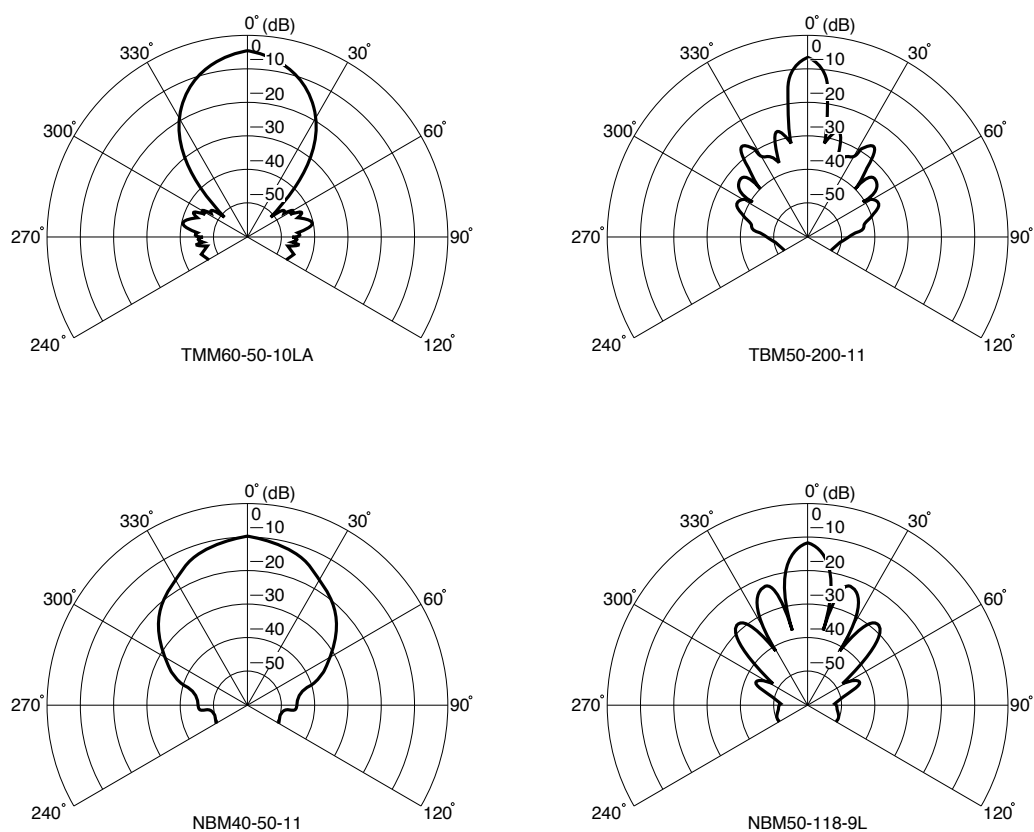

Fig. 6-4 Directivity

**Note:** Transducers with non-standard shapes and dimensions are also available. For inquiries, see page 34.



- All specifications in this catalog and production status of products are subject to change without notice. Prior to the purchase, please contact NEC TOKIN for updated product data.
- Please request for a specification sheet for detailed product data prior to the purchase.
- Before using the product in this catalog, please read "Precautions" and other safety precautions listed in the printed version catalog.



# High-Frequency Transducers

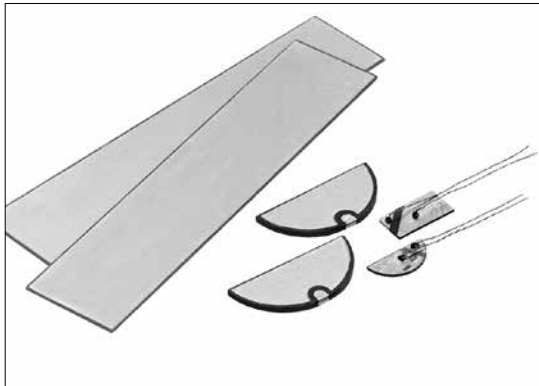

## Outline

Compared to ordinary piezoelectric transducers, these types operate at much higher frequencies: usually in the 1~10 MHz range. One of the primary applications of high-frequency transducers is as a sensor for flaw detection. Another important application area is medical equipment; in fact, with ultrasonic diagnosis becoming ever more widespread, HF piezoelectric transducers are the focus of increasing attention.

Here are some of the types of ultrasonic diagnosis that require HP transducers:

Doppler system: { Fetus phonocardiographs  
Blood flowmeter

Pulse echo system: { Tomography { Electron scanning  
Mechanical scanning  
Cranial disease diagnosis  
Cardiac wall displacement measurement

The vibration mode of these transducers is usually thickness resonance, and the frequency is high. For this reason, thin plate transducers with low impedance at resonance are needed. The dielectric constant of NEC TOKIN NEPEC® is low, and its impedance characteristics and other performance parameters are excellent for use in high-frequency transducers.

## Features

- High impedance at resonant frequency.
- Excellent electromechanical coupling in thickness vibration mode.
- High sensitivity.
- Both thickness and radial vibration offer good anisotropic properties.
- Thickness resonance spurious emissions are low, and resolution is excellent.

## Specifications Example

Table 4-3

Shape	Material	Dimensions (mm)			Characteristics				
		d	t	ℓ	f <sub>r</sub> (kHz)	K <sub>r</sub>	K <sub>31</sub>	C (PF)	Terminal
	21	20	0.5	—	4,000	0.60	—	7,000	S
	21	10	0.3	—	6,400	0.57	—	3,000	S
	21	20	0.3	20	6,500	—	0.30	13,500	P
	21	20	0.4	20	5,000	—	0.30	10,500	P
	21	25	0.5	25	4,000	—	0.30	14,000	P
	21	15	0.3	80	6,500	—	0.30	42,000	P
	21	15	0.4	80	5,000	—	0.30	32,500	P
	21	15	0.5	100	4,000	—	0.30	33,000	P
	21	15	0.6	100	3,000	—	0.30	28,500	P



- All specifications in this catalog and production status of products are subject to change without notice. Prior to the purchase, please contact NEC TOKIN for updated product data.
- Please request for a specification sheet for detailed product data prior to the purchase.
- Before using the product in this catalog, please read "Precautions" and other safety precautions listed in the printed version catalog.

# Aerial Microphone Transducers



## Outline

Ultrasonic aerial microphones generate ultrasonic waves that are radiated through the air and reflected from a target to measure distance. These microphones are used for traffic control, obstacle detection, robot sensors, and other similar applications.

There are two types of aerial microphone with different vibration modes, bimorph type and cylindrical type. Such transducers are most often used together with a horn mounted in the radiation plane. NEC TOKIN aerial microphone transducers have good output power, receiving sensitivity and directivity-all important in this type of application.

## Features

- Good temperature characteristics.
- Cylindrical transducers are moisture-resistant, ensuring stable operation outdoors.
- High mechanical coupling, high sensitivity.

## Specifications of Standard Models

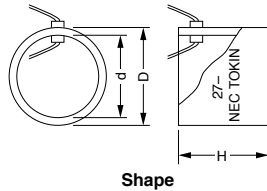

Table 4-4 N-21 Specification Example

D (mm)	d (mm)	H (mm)	fr (kHz)	K	C (PF)
38	34	30	23.7	0.25	28000
36	31	30	25.8	0.25	19600

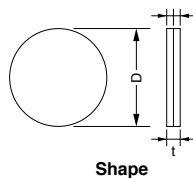

Table 4-5 N-6 Specification Example

D (mm)	t (mm)	fr (kHz)	$\Delta f$ (kHz)	C (PF)
18.7	1.5	23.5	2.0	2100

## Circuit Example

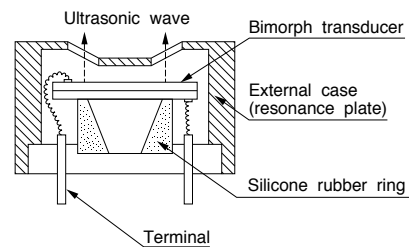
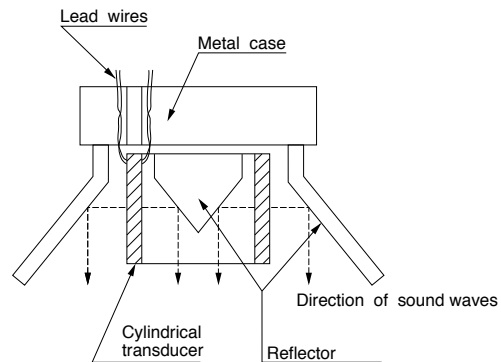

Fig. 6-5 Details of Construction



- All specifications in this catalog and production status of products are subject to change without notice. Prior to the purchase, please contact NEC TOKIN for updated product data.
- Please request for a specification sheet for detailed product data prior to the purchase.
- Before using the product in this catalog, please read "Precautions" and other safety precautions listed in the printed version catalog.

# Sonar Transducers

## Outline

Depth finders, underwater detectors, and fish finders all utilize the principle of sonar, in which sound waves are radiated through the water to detect and measure the distance to the target. Although there are differences in the resolution and distance capabilities required of sonar transducers, in general all should have the best possible sensitivity, resolution, directivity, and reliability. Sonar transducers fabricated of NEC TOKIN's superior NEPEC® material score high marks in all departments, and are available for a wide variety of applications.

## Characteristics of Sonar Transducer Materials

Table 4-6

Transducer type	Vibration mode	Operating frequency	Main features	Remarks
a Disc	Thickness vibration	70 ~ 500	Easy frequency adjustment High mechanical strength	
b Square column	Longitudinal vibration	40 ~ 100	Easy frequency adjustment Good electromechanical coupling	Dimensions and characteristics are determined according to the requirements of specific customers.
c Cylinder	Thickness vibration	100 ~ 500	Adjustment of mechanical Q and frequency are easy	
	Diameter direction vibration	10 ~ 200		
d Langevin	Longitudinal vibration	20 ~ 100	Low frequency can be obtained at low impedance	

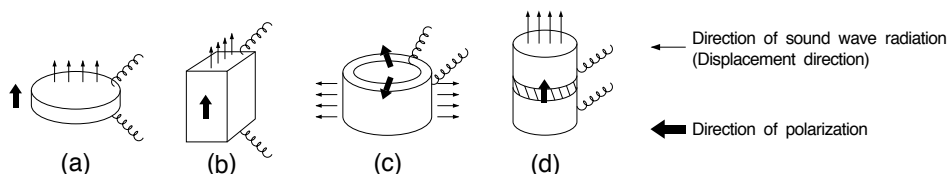

Fig. 6-6

## Types and Features

Table 4-7

Material	$K_{31}$	$\epsilon_{33}^T/\epsilon_0$	$Q_m$	$T_c$ (°C)	Features
N-6	0.34	1400	1500	325	Excellent stability at high output levels
N-21	0.38	1800	75	300	Low $Q_m$ and high sensitivity



- All specifications in this catalog and production status of products are subject to change without notice. Prior to the purchase, please contact NEC TOKIN for updated product data.
- Please request for a specification sheet for detailed product data prior to the purchase.
- Before using the product in this catalog, please read "Precautions" and other safety precautions listed in the printed version catalog.



- All specifications in this catalog and production status of products are subject to change without notice. Prior to the purchase, please contact NEC TOKIN for updated product data.
- Please request for a specification sheet for detailed product data prior to the purchase.
- Before using the product in this catalog, please read "Precautions" and other safety precautions listed in the printed version catalog.



- All specifications in this catalog and production status of products are subject to change without notice. Prior to the purchase, please contact NEC TOKIN for updated product data.
- Please request for a specification sheet for detailed product data prior to the purchase.
- Before using the product in this catalog, please read "Precautions" and other safety precautions listed in the printed version catalog.



- All specifications in this catalog and production status of products are subject to change without notice. Prior to the purchase, please contact NEC TOKIN for updated product data.
- Please request for a specification sheet for detailed product data prior to the purchase.
- Before using the product in this catalog, please read "Precautions" and other safety precautions listed in the printed version catalog.

# Precautions



- The names of the products and the specifications in this catalog are subject to change without notice for the sake of improvement. The manufacturer also reserves the right to discontinue any of these products. At the time of delivery, please ask for specification sheets to check the contents before use.
- Material selection, installation and activation of piezoelectric ceramics should be decided upon by users according to the application. For proper evaluation and decision, products should be tested repeatedly in both realistic and abnormal operating conditions.
- The manufacturer's warranty will not cover any disadvantage or damage caused by improper use of the products, deviating from the characteristics, specifications, or conditions for use described in this catalog.
- Please be advised that the manufacturer accepts no responsibility for any infringement on third party patents or industrial copyrights by users of the manufacturer's products. The manufacturer is responsible only when such infringements are attributable to the structural design of the product and its manufacturing process.
- No part of this document may be reproduced without written permission from the manufacturer.
- Export Control  
For customers outside Japan  
NEC-TOKIN products should not be used or sold for use in the development, production, stockpiling or utilization of any conventional weapons or mass-destructive weapons (nuclear weapons, chemical or biological weapons, or missiles), or any other weapons.  
For customers in Japan  
For products which are controlled items subject to the 'Foreign Exchange and Foreign Trade Law' of Japan, the export license specified by the law is required for export.
- When ordering NEPEC Piezoelectric Materials  
Specify the following items when placing an order with NEC TOKIN for NEPEC :
  - 1) Shape (disc, column, cylinder, square plate, sphere, or bimorph).
  - 2) Desired material and application.
  - 3) Dimensions.
  - 4) Vibration mode and resonant frequency used.
  - 5) Whether special surface treatment is required, and if so, what type.
  - 6) S, P, or other designated terminal.
- When ordering transducers or other finished products  
Specify model name and number when placing an order for transducer products such as molded transducers for underwater use. Also note any special requirements.
- This catalog is current as of September 2013.



- All specifications in this catalog and production status of products are subject to change without notice. Prior to the purchase, please contact NEC TOKIN for updated product data.
- Please request for a specification sheet for detailed product data prior to the purchase.
- Before using the product in this catalog, please read "Precautions" and other safety precautions listed in the printed version catalog.